



P5100

User Manual

Version 1.0



Copyright 2023 Colormetrics. All Rights Reserved.

This manual, software and firmware described in it are copyrighted by their respective owners and protected under the laws of the Universal Copyright Convention. You may not reproduce, transmit, transcribe, store in a retrieval system, or translate into any language, in any form or by any means, electronic, mechanical, magnetic, optical, chemical, biological, molecular, manual, or otherwise, any part of this publication without the express written permission of the publisher.

All products and trade names described within are mentioned for identification purpose only. No affiliation with or endorsement of the manufacturer is made or implied. Product names and brands appearing in this manual are registered trademarks of their respective companies.

The information published herein has been checked for accuracy as of publishing time. No representation or warranties regarding the fitness of this document for any use are made or implied by the publisher. We reserve the right to revise this document or make changes in the specifications of the product described therein at any time without notice and without obligation to notify any person of such revision or change.

Safety Instructions

1. Read these instructions carefully. Keep these instructions for future reference.
2. Please disconnect this equipment from AC outlet before cleaning. Don't use liquid or sprayed detergent for cleaning. Use moisture sheet or cloth for cleaning.
3. Please keep this equipment from humidity.
4. Lay this equipment on a reliable surface when install. A drop or fall could cause injury.
5. Make sure power cord such a way that people cannot step on it. Do not place anything over the power cord.
6. All cautions and warnings on the equipment should be noted.
7. If the equipment is not used for long time, disconnect the equipment from main to avoid being damaged by transient over voltage.
8. Never pour any liquid into opening; this could cause fire or electrical shock.
9. If one of the following situations arises, get the equipment checked by a service personnel:
 - a. The power cord or plug is damaged.
 - b. Liquid has penetrated into the equipment.
 - c. The equipment has been exposed to moisture.
 - d. The equipment does not work well or you cannot get it work according to user manual.
 - e. The equipment has dropped and damaged.
10. Do not leave this equipment in an environment unconditioned, storage temperature below -20 °C or above 60 °C, it may damage the equipment.
11. Unplug the power cord when doing any service or adding optional kits.

Lithium Battery Caution:

1. Danger of explosion can happen if the battery is incorrectly replaced. Replace only the original or equivalent type recommended by the manufacture. Dispose used batteries according to the manufacturer's instructions.
2. Do not remove the cover, and ensure no user serviceable components are inside. Take the unit to the service center for service and repair.

CE Notice

This device complies with the requirements of the CE directive.

FCC Notice

This equipment has been tested and found to comply with the limits for a Class A digital device, pursuant to Part 15 of the FCC rules. These limits are designed to provide reasonable protection against harmful interference in a residential installation. This equipment generates uses and can radiate radio frequency energy and, if not installed and used in accordance with the instructions, may cause harmful interference to radio communications. However, there is no guarantee that interference will not occur in a particular installation. If this equipment does cause harmful interference to radio or television reception, which can be determined by turning the equipment off and on, the user is encouraged to try to correct the interference by one or more of the following measures:

- Reorient or relocate the receiving antenna.
- Increase the separation between the equipment and receiver.
- Connect the equipment into an outlet on a circuit different from that to which the receiver is connected.
- Consult the dealer or an experienced radio/TV technician for help.

Shielded interface cables must be used in order to comply with emission limits.

Changes or modifications not expressly approved by the party responsible for compliance could void the user's authority to operate the equipment.

WEEE Notice

This appliance is labeled in accordance with European Directive 2002/96/EC concerning waste electrical and electronic equipment (WEEE). The Directive determines the framework for the return and recycling of used appliances as applicable throughout the European Union. This label is applied to various products to indicate that the product is not to be thrown away, but rather reclaimed upon end of life per this Directive.



Copyright.....

Safety Instructions.....

CE /FCC/ WEEE Notice

1. Packing List..... 3

1-1 Standard Accessories 3

1-2 Optional Accessories..... 3

2. System View..... 4

2-1 Front View 4

2-2 Back View 4

2-3 Specification 5

2-4 Internal Layout 6

3. Pin Definition 7

4. Rear I/O Interface 14

5. System Assembly & Disassembly 17

5-1. M.2 SSD / Memory 178

5-2. Memory 19

5-3. MSR 19

5-4. i-Button / Scanner 19

5-5. VFD/2nd monitor module replacement 20

6. Device Driver Installation 21

6-1. MagSwipe Card Reader Configuration Utility 21

6-2. i-Button reader Configuration utility 32

6-3. VFD 38

7. BIOS/Utility setup 49

7-1. Advanced 52

7-1-2. Audio Configuration 54

7-2. Security 57

7-3. Power 58



7-4. Boot 59

7-5. Exit 60





8. LCD surface cleaning 61

PACKING LIST

1 Standard Accessories

a.		a. System x1
		b. 60W / 90W /150W Power Adapter c. Power Cord x1
		d. Cable D-SUB to RJ45 X3

2 Optional Accessories

		
	<p>a. MSR b. 2D barcode scanner c. VFD / 2nd Display 9.7" , 15" d. RFID / I-BUTTON / Fingerprint</p>	

2

System View

2-1 Rear View Standard

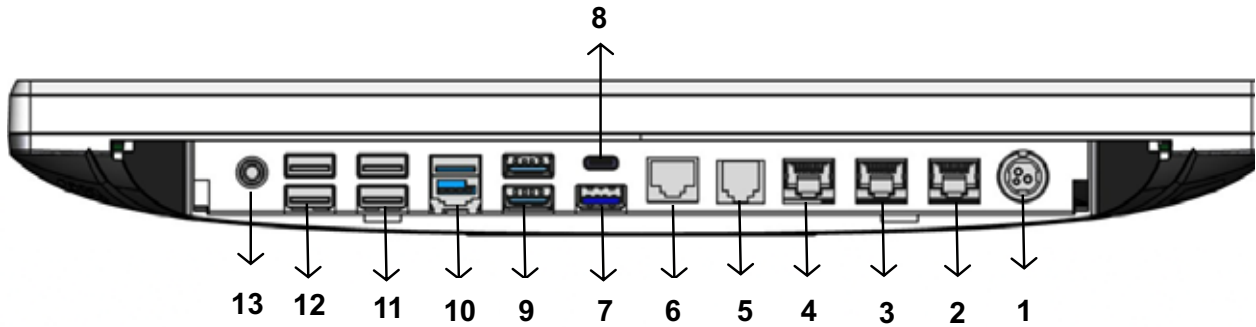

Item

- | | |
|----------------------|---|
| 1. 19V DC Input | 10. 24V Power USB (Option 150W Adapter) |
| 2. COM1 | 11. USB 2.0 X2 |
| 3. COM2 | 12. USB 2.0 X2 |
| 4. COM3 | 13. Line Out |
| 5. RJ11(Cash Drawer) | |
| 6. LAN port | |
| 7. USB3.0 | |
| 8. Type-C USB | |
| 9. USB3.0 | |

2-2 Back View

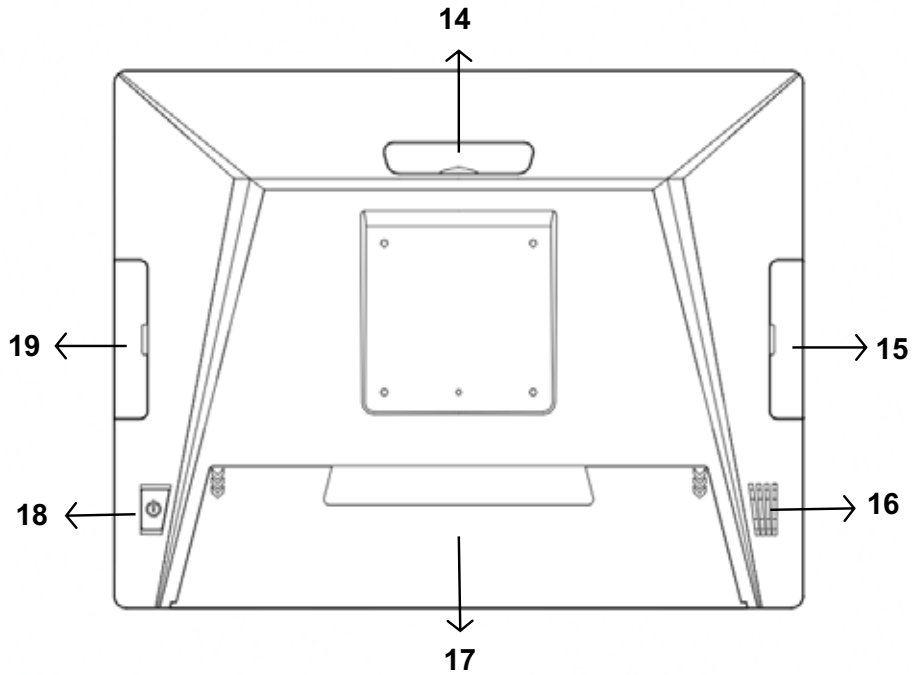

Item

- | | |
|---|--------------------|
| 14. VFD / 2nd Display 9.7", 15" (Option) | 17. Cable Cover |
| 15. MSR/ i-Button/ RFID/ Barcode scanner (Option) | 18. Power Button |
| 16. Speaker | 19. M.2 Storage X2 |

SYSTEM VIEW

2-3 Specification

del		Ares550		
Display	Display Size	15" TFT LCD		
	Resolution	1024 X 768		
	Brightness / Color	300 cd/m ² , 16.2M colors		
	Backlight	LED		
Touch Panel	Type	Projected capacitive touch		
Processor	CPU/ Chipset	Intel® Celeron® Elkhart Lake J6412		
Memory	X 2 SO-DIMM socket supports up to 32GB			
Storage	X 1 (M.2 SSD M-Key supports 2242 & 2280) NVMe PCI-e Gen3 x 4			
	X 1 (M.2 SSD M-Key Supports 2242 & 2280) only SATA			
I/O Connectors	USB 2.0	X 5 (Rear X 4, Side X 1)		
	USB 3.2 Gen1	X 3 (Rear)		
	USB Type-C 3.2 Gen1	X1		
	WIFI	X1 E-Key (Supports WIFI & Bluetooth)		
	Powered COM	X3 (RJ45 Powered COM 5V/ 12V selected by BIOS)		
	Powered USB 2.0	X1 Powered USB 24V (Retain adapter 150W)		
	Cash Drawer Port	X 1 (24V RJ11 cash drawer port)		
	Audio Port	Speaker	X1 (2W)	
		Line Out	X1	
	LAN	x 1 (RJ45 10/ 100/ 1000 Base-T)		
DC In	Lockable 3-pin DC input			
Optional Peripherals	VFD/ 2 nd display 9.7",15"/ MSR/ iButton/ RFID/ Fingerprint/ 2D Scanner			
Power Supply	60W / Option 90W/ 150W 19V lockable 3-pin power adapter			
OS Support	Windows 10 IoT			
Environment	Temperature	Operation	32° to 95° F (0° to 35° C)	
		Storage	-4° to 140° F (-20° to 60° C)	
	Relative Humidity	20% to 80% non-condensing		
Dimension (W x H x D) mm	333 x 220 x 346 mm			
Certifications	CE/ FCC/ LVD			
Protection	IP64 on front bezel			

☆ Please make sure 19V DC plug in the right direction before plugging in DC jack.

2-5 Internal Layout

2-4 Mainboard Layout

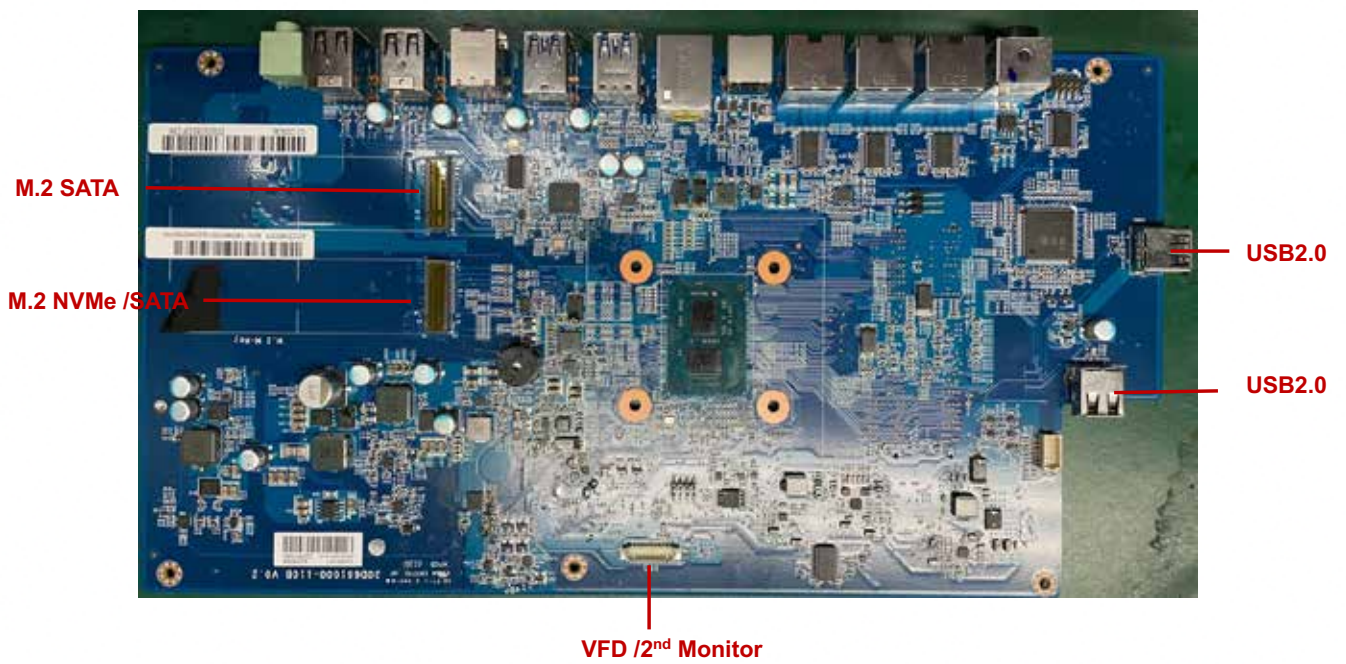
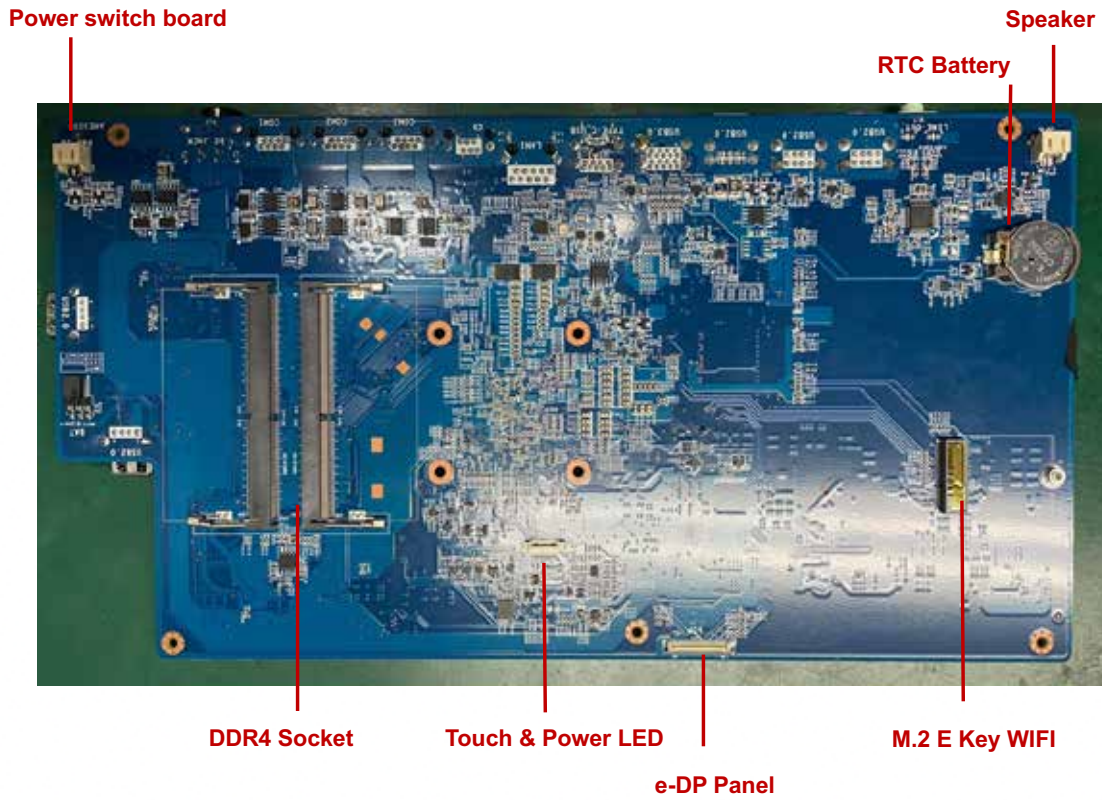

1. Main PCAB

1. M.2: PCIE +SATA Pin Definition

No.	Definition	Description	No.	Definition	Description
1	M_2_PRESENCE	Ground	39	GND	Ground
2	+VCC3	+VCC3	40	N/C	Not connected
3	GND	Ground	41	M.2_SATA-RX+/PERN0	M.2_M_Key_SATA-RX+
4	+VCC3	+VCC3	42	N/C	Not connected
5	PCIE3_RX-	M_Key_PERN3	43	M.2_SATA-RX-/PREP0	M.2_M_Key_SATA-RX-
6	NC	Not connected	44	N/C	Not connected
7	PCIE3_RX+	M_Key_PERP3	45	GND	Ground
8	N/C	Not connected	46	N/C	Not connected
9	GND	Ground	47	M.2_SATA-TX-/PETN0	M.2_M_Key_SATA-TX-
10	M_2_W_LED	UP +VCC3	48	N/C	Not connected
11	PCIE3_TX-	M_Key_PETN3	49	M.2_SATA-TX+/PETP0	M.2_M_Key_SATA-TX+
12	+VCC3	+VCC3	50	PERST_N	BUF_PLTRST_N
13	PCIE3_TX+	M_Key_PETP3	51	GND	Ground
14	+VCC3	+VCC3	52	CLKREQ_N	PCIE*2_CLKREQ0#
15	GND	Ground	53	REFCLK_N	PCIE2_CLK_PEIC*2_N
16	+VCC3	+VCC3	54	PEWAKE_N	WAKE_3P3_N
17	PCIE2_RX-	M_Key_PERN2	55	REFCLK_P	PCIE2_CLK_PEIC*2_P
18	+VCC3	+VCC3	56	N/C	Not connected
19	PCIE2_RX+	M_Key_PERP2	57	GND	Ground
20	N/C	Not connected	58	N/C	Not connected
21	GND	Ground	59	N/C	Not connected
22	N/C	Not connected	60	N/C	Not connected
23	PCIE2_TX-	M_Key_PETN2	61	N/C	Not connected
24	N/C	Not connected	62	N/C	Not connected
25	PCIE2_TX+	M_Key_PETP2	63	N/C	Not connected
26	N/C	Not connected	64	N/C	Not connected
27	GND	Ground	65	N/C	Not connected
28	N/C	Not connected	66	N/C	Not connected
29	PCIE1_RX-	M_Key_PERN1	67	N/C	Not connected
30	N/C	Not connected	68	N/C	Not connected
31	PCIE1_RX+	M_Key_PERP1	69	M_2_PEDET_OC	UP +VCC3

PIN DEFINITION

32	N/C	Not connected	70	+VCC3	+VCC3
33	GND	Ground	71	GND	Ground
34	N/C	Not connected	72	+VCC3	+VCC3
35	PCIE1_TX-	M_Key_PETN1	73	GND	Ground
36	N/C	Not connected	74	+VCC3	+VCC3
37	PCIE1_TX+	M_Key_PETP1	75	M_2_PEDET_GND- OTHER	Ground
38	M_2_DEVSLP	Ground			

2. CN12: eDP connector

No.	Definition	No.	Definition
1	NC	16	GND
2	GND	17	EDP_HPDP
3	EDP_TX1_DN	18	GND
4	EDP_TX1_DP	19	GND
5	GND	20	GND
6	EDP_TX0_DN	21	GND
7	EDP_TX0_DP	22	BL_Enable
8	GND	23	BL PWM DIM
9	EDP1_AUX_P	24	NC
10	EDP1_AUX_N	25	NC
11	GND	26	+12V
12	+V3.3V	27	+12V
13	+V3.3V	28	+12V
14	NC	29	+12V
15	GND	30	NC

3. M_2: SATA Pin Definition

No.	Definition	Description	No.	Definition	Description
1	M_2_PRESENCE	Ground	39	GND	Ground
2	+VCC3	+VCC3	40	N/C	Not connected
3	GND	Ground	41	M.2_SATA-RX+	SATA RX+
4	+VCC3	+VCC3	42	N/C	Not connected
5	GND	Ground	43	M.2_SATA-RX-	SATA RX-
6	N/C	Not connected	44	GND	Ground
7	N/C	Not connected	45	GND	Ground
8	M_2_W_D	+VCC3	46	N/C	Not connected
9	N/C	Not connected	47	M.2_SATA-TX-	SATA TX-
10	M_2_W_LED	UP_+VCC3	48	N/C	Not connected

PIN DEFINITION

11	GND	Ground	49	M.2_SATA-TX+	SATA TX+
12	N/C	Not connected	50	GND	Ground
13	N/C	Not connected	51	GND	Ground
14	N/C	Not connected	52	N/C	Not connected
15	N/C	Not connected	53	N/C	Not connected
16	N/C	Not connected	54	N/C	Not connected
17	N/C	Not connected	55	N/C	Not connected
18	N/C	Not connected	56	N/C	Not connected
19	N/C	Not connected	57	GND	Ground
20	N/C	Not connected	58	N/C	Not connected
21	M_2_WWAN	Ground	59	N/C	Not connected
22	N/C	Not connected	60	N/C	Not connected
23	N/C	Not connected	61	N/C	Not connected
24	N/C	Not connected	62	N/C	Not connected
25	N/C	Not connected	63	N/C	Not connected
26	N/C	Not connected	64	N/C	Not connected
27	GND	Ground	65	N/C	Not connected
28	N/C	Not connected	66	N/C	Not connected
29	N/C	Not connected	67	N/C	Not connected
30	N/C	Not connected	68	N/C	Not connected
31	N/C	Not connected	69	M_2_PEDET_OC	UP_+VCC3
32	N/C	Not connected	70	+VCC3	+VCC3
33	GND	Ground	71	GND	Ground
34	N/C	Not connected	72	+VCC3	+VCC3
35	N/C	Not connected	73	GND	Ground
36	N/C	Not connected	74	+VCC3	+VCC3
37	N/C	Not connected	75	M_2_PEDET_GND-OTHER	Ground
38	M_2_DEVSLP	Ground			

4. NGFF1: M.2 WIFI Pin Definition

No.	Definition	Description	No.	Definition	Description
1	GND	Ground	38	N/C	Not connected
2	+VCC3	+3.3V	39	GND	Ground
3	NGFF1_D+	USB Data+	40	N/C	Not connected
4	+VCC3	+3.3V	41	PE_RXP3	PCIE RX+
5	NGFF1_D-	USB Data-	42	N/C	Not connected
6	N/C	Not connected	43	PE_RXN3	PCIE RX-
7	GND	Ground	44	N/C	Not connected
8	N/C	Not connected	45	GND	Ground
9	N/C	Not connected	46	N/C	Not connected

PIN DEFINITION

10	N/C	Not connected	47	CLK_PCIE2_100MHZ_P	PCIE CLK+
11	N/C	Not connected	48	N/C	Not connected
12	N/C	Not connected	49	CLK_PCIE2_100MHZ_N	PCIE CLK-
13	N/C	Not connected	50	SUS_CLK	SUS_CLK
14	N/C	Not connected	51	GND	Ground
15	N/C	Not connected	52	NGFF_WIFI_RST	PCIE_RST
16	N/C	Not connected	53	CLKREQ#1	PCIECLKRQ3#
17	N/C	Not connected	54	NGFF1_W_D#2	+3.3V
18	GND	Ground	55	PCH_WAKE#	PCIE_WAKE#
19	N/C	Not connected	56	NGFF1_W_D#3	+3.3V
20	N/C	Not connected	57	GND	Ground
21	N/C	Not connected	58	N/C	Not connected
22	N/C	Not connected	59	N/C	Not connected
23	N/C	Not connected	60	N/C	Not connected
24	N/C	Not connected	61	N/C	Not connected
25	N/C	Not connected	62	N/C	Not connected
26	N/C	Not connected	63	GND	Ground
27	N/C	Not connected	64	N/C	Not connected
28	N/C	Not connected	65	N/C	Not connected
29	N/C	Not connected	66	N/C	Not connected
30	N/C	Not connected	67	N/C	Not connected
31	N/C	Not connected	68	N/C	Not connected
32	N/C	Not connected	69	GND	Ground
33	GND	Ground	70	N/C	Not connected
34	N/C	Not connected	71	N/C	Not connected
35	PE_TXP3	PCIE TX+	72	+VCC3	+3.3V
36	N/C	Not connected	73	N/C	Not connected
37	PE_TXN3	PCIE TX-	74	+VCC3	+3.3V

5. CN6: Mini-PCIE Pin Definition

No.	Definition	Description	No	Definition	Description
1	PCIE_WAKE_N	PCIE Wake Event	29	GND	Ground
2	3.3V	+3.3V	30	SMB_PCIE_DBG_CLK	SMBus Clock
3	N/C	Not connected	31	PCIE_TX3_MINI_DN	PCIE Transmit-
4	GND	Ground	32	SMB_PCIE_DBG_DATA	SMBus Data
5	N/C	Not connected	33	PCIE_TX3_MINI_DP	PCIE Transmit+
6	1.5V	+1.5V	34	GND	Ground
7	CLKREQ#	+3.3V	35	GND	Ground
8	N/C	Not connected	36	USB Data-	USB D-
9	GND	Ground	37	N/C	Not connected

PIN DEFINITION

10	N/C	Not connected	38	USB Data+	USB D+
11	CLK_PCIE_MINI_N	PCIE output clock-	39	N/C	Not connected
12	N/C	Not connected	40	GND	Ground
13	CLK_PCIE_MINI_P	PCIE output clock+	41	N/C	Not connected
14	N/C	Not connected	42	N/C	Not connected
15	GND	Ground	43	N/C	Not connected
16	N/C	Not connected	44	N/C	Not connected
17	N/C	Not connected	45	N/C	Not connected
18	GND	Ground	46	N/C	Not connected
19	N/C	Not connected	47	N/C	Not connected
20	W_DISABLE#	+3.3V	48	1.5V	+1.5V
21	GND	Ground	49	N/C	Not connected
22	RESET#	Platform Reset	50	GND	Ground
23	PCIE_RX3_MINI_DN	PCIE Receive-	51	N/C	Not connected
24	3.3V	+3.3V	52	3.3V	+3.3V
25	PCIE_RX3_MINI_DP	PCIE Receive+			
26	GND	Ground			
27	GND	Ground			
28	1.5V	+1.5V			

6. J3: eDP pin Definition

No.	Definition	No.	Definition
1	NC	16	GND
2	GND	17	EDP_HPDP
3	EDP_TX1_DN	18	GND
4	EDP_TX1_DP	19	GND
5	GND	20	GND
6	EDP_TX0_DN	21	GND
7	EDP_TX0_DP	22	BL_Enable
8	GND	23	BL_PWM_DIM
9	EDP1_AUX_P	24	NC
10	EDP1_AUX_N	25	NC
11	GND	26	+12V
12	+V3.3V	27	+12V
13	+V3.3V	28	+12V
14	NC	29	+12V
15	GND	30	NC

7. VFD: Power Button Pin Definition

No.	Definition
1	GND
2	TxD
3	RxD
4	DSR#
5	DTR#
6	+5V
7	+5V
8	USB D-
9	USB D+
10	GND

8. SPK1: nt. Speaker Pin Definition

No.	Definition
1	Right Out+
2	Right Out-

9. CN4: Touch +LED Pin Definition

No.	Definition
1	+VCC5
2	USB D-
3	USB D+
4	GND
5	LED-
6	LED+

10. SW2: Power Button Pin Definition

No.	Definition
1	Power-ON#
2	GND

11. JBAT1: Power Button Pin Definition

No.	Definition
1	GND
2	Recovery
3	RTCRST#
4	SRTCRST#
5	GND
6	GND

12. J6: LPC TPM Pin Definition

No.	Definition	No.	Definition
1	LPC_AD0	2	LPC_AD1
3	LPC_AD2	4	LPC_AD3
5	LPC_FRAME#	6	PLTRST_N
7	GND	8	GND
9	CLK	10	CLK
11	GND	12	SERIRQ
13	+VCC3	14	+VCC3
15	+VCC3	16	+VCC3

13. BAT1: RTC Battery Pin Definition

No.	Definition
1	BAT1
2	GND

System**1. JS1: DC Jack Pin Definition**

No.	Definition
1	+19V
2	Ground
3	+19V

2. 2-Layer USB3.0 connector

No.	Definition	No.	Definition
1	+5V	10	+5V
2	D-	11	D-
3	D+	12	D+
4	GND	13	GND
5	RX-	14	RX-
6	RX+	15	RX+
7	GND	16	GND
8	TX-	17	TX-
9	TX+	18	TX+

3. LAN: RJ45

No.	Definition
1	MDI0A+
2	MDI0A-
3	MDI1A+
4	MDI1A-
5	MDI2A+
6	MDI2A-
7	MDI0A+
8	MDI0A-
9	MDI3A+
10	MDI3A-

4. USB5: TYPE-C USB USB3.0 pin Definition

No.	Definition	No.	Definition
A1	GND	B1	GND
A2	TX1+	B2	TX2+
A3	X1-	B3	TX2-
A4	VBUS	B4	VBUS
A5	TYPE_C_CC1	B5	TYPE_C_CC2
A6	USB_D+	B6	USB_D+
A7	USB_D-	B7	USB_D-
A8	TYPE_C_SBU1	B8	TYPE_C_SBU2
A9	VBUS	B9	VBUS
A10	RX2-	B10	RX1-
A11	RX2+	B11	RX1+
A12	GND	B12	GND

5. USB5: TYPE-C DP: Type-C auto mode pin definition

No.	Definition	No.	Definition
A1	GND	B1	GND
A2	TX1+_C	B2	TX2+_C
A3	TX1-_C	B3	TX2-_C
A4	VBUS_OUT	B4	VBUS_OUT
A5	TYPE_C_CC1	B5	TYPE_C_CC2
A6	USB_D+	B6	USB_D+
A7	USB_D-	B7	USB_D-
A8	TYPE_C_SBU1	B8	TYPE_C_SBU2
A9	VBUS_OUT	B9	VBUS_OUT
A10	RX2-_C	B10	RX1-_C
A11	RX2+_C	B11	RX1+_C
A12	GND	B12	GND

6. CN1, CN2 USB2.0 pin definition type A

No.	Definition	No.	Definition
1	+5V	5	+5V
2	USB_D-	6	USB_D-
3	USB_D+	7	USB_D+
4	GND	8	GND

7. USB1, USB2: USB 2.0 pin definition (Internal USB 2.0 type A)

No.	Definition
1	+5V
2	USB_D-
3	USB_D+
4	GND

8. 24V USB1: USB 2.0 and 24V pin definition

No.	Definition	No.	Definition
1	+5V	5	Dect#
2	USB_D-	6	+24V
3	USB_D+	7	+24V
4	GND	8	GND

9. J5: LINE-OUT JACK Pin Definition

No.	Definition
1	GND_AUD
2	GND_AUD
3	LINE_OUTR2
4	LINE_OUTL2
5	LINE2-JD

10. LAN1: RJ45 Pin Definition

No.	Definition
1	MDI0A+
2	MDI0A-
3	MDI1A+
4	MDI1A-
7	MDI2A+
8	MDI2A-
9	MDI3A+
10	MDI3A-

11. COM1, COM2, COM3 RJ45 TYPE : Pin Definition

No.	Definition
1	5V/12V/Ring#
2	DSR#
3	GND
4	DTR#
5	RTS#
6	CTS#
7	TxD
8	RxD

12. CN6: RJ11 (Cash Drawer) connector Pin Definition

No.	Definition
1	GND
2	C/D_OPEN#
3	C/D_Status
4	+24V
5	NC
6	GND

5

System Assembly & Disassembly

5-1 M.2 SSD / Memory



1. Remove the side cover.
2. Loosen 2 screws.
3. Pull out the tray.

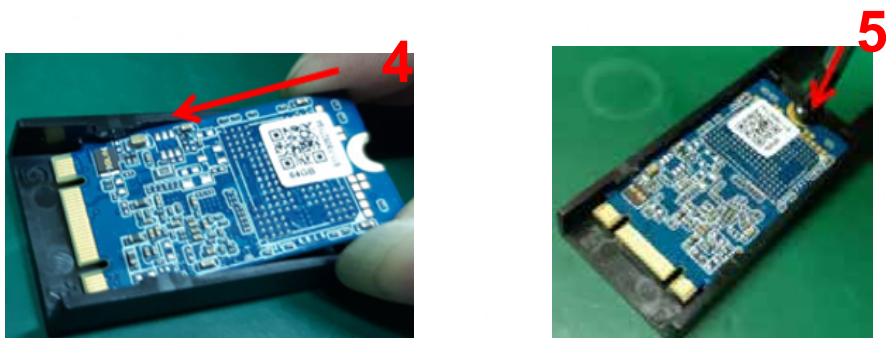
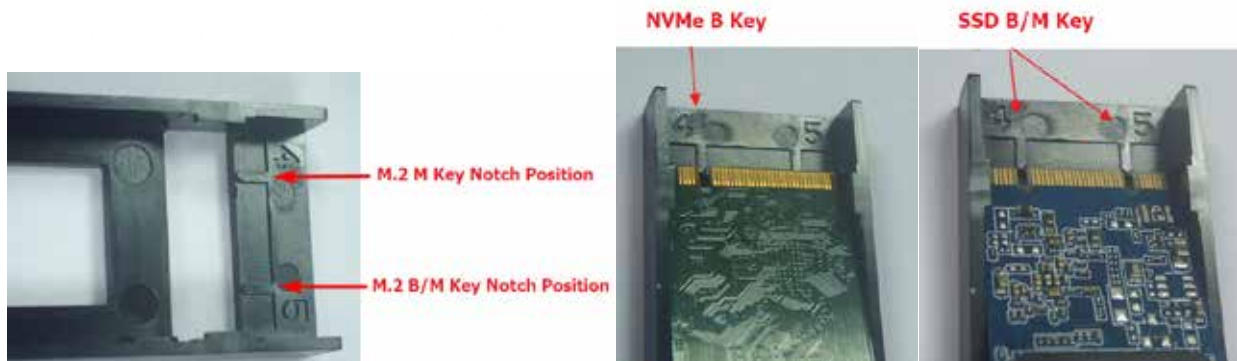

4. Caution: Please check the position of the gap between the tray and the M.2 storage.
The wrong installation position will damage the M/B and cancel the warranty.
5. Install the M.2 SSD with 1 screw.

5-2 Install the memory



1. Remove the cable cover.
2. Loosen 1 screw.
3. Slide up to separate the panel.
4. Install the memory.

5-3 MSR

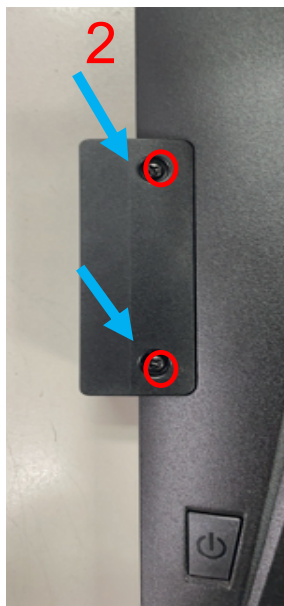

1. Remove the MSR cover.
2. Install and fasten the module with two screws.

5-4 i-Button / Scanner



1. Remove the MSR cover.
2. Install and fasten the module with two screws.

5-5. VFD / 15" 9.7" 2nd display

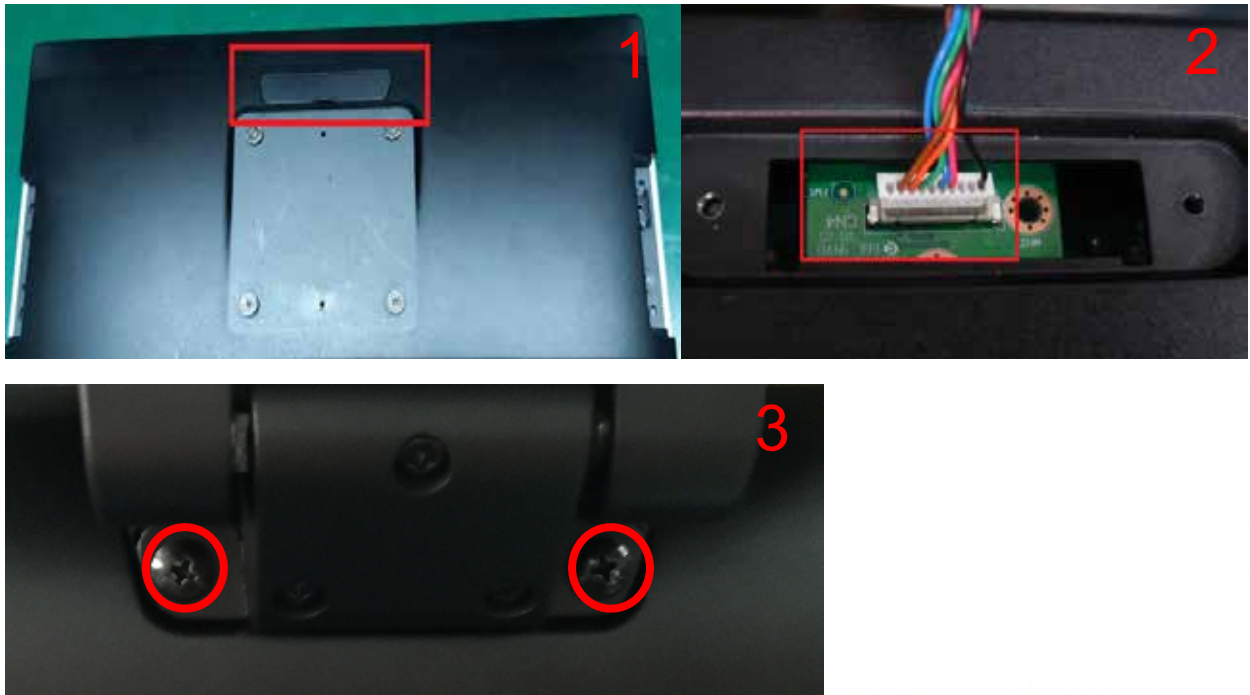

1. Remove the VFD cover.
2. Connect cable into M/B.
3. Fasten with 2 screws.

6-1. MagSwipe Card Reader Configuration Utility

The MagSwipe Configuration Utility is used to set up the output format of MagSwipe

Installation

The steps below guide you how to install the Utility program

- Insert the setup CD
- Run the **80066804-009_MagSwipe_Cfg_v2.3.5_A** setup file that is located in the Software folder of CD.
- Follow the wizard to complete the installation.

Launching Program

The steps below guide you how to load the **Utility** program.

- From **Start/Programs**, click **MagSwipe** folder
- Click **MagSwipe Configuration Utility** to launch the program.

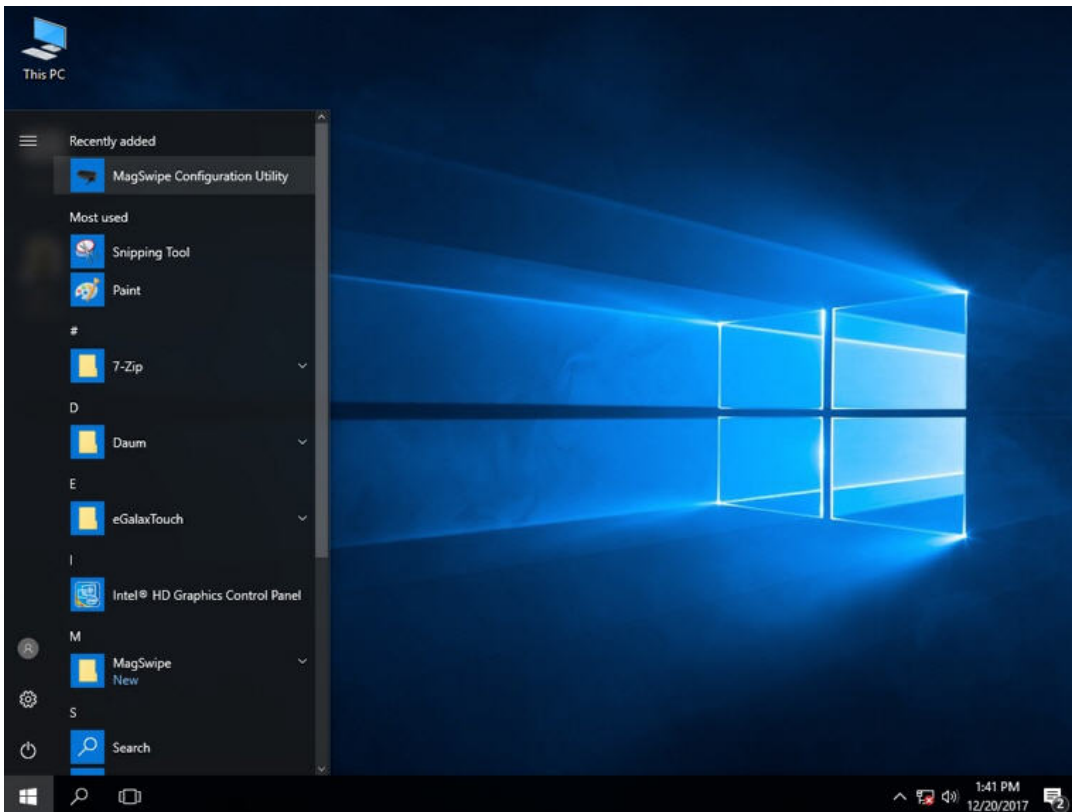

Configuration



Select Reader Interface

The reader to be configured should be connected. Select the corresponding connected reader interface and click the **Continue** button.

IDTECH[®] MagSwipe Configuration Utility

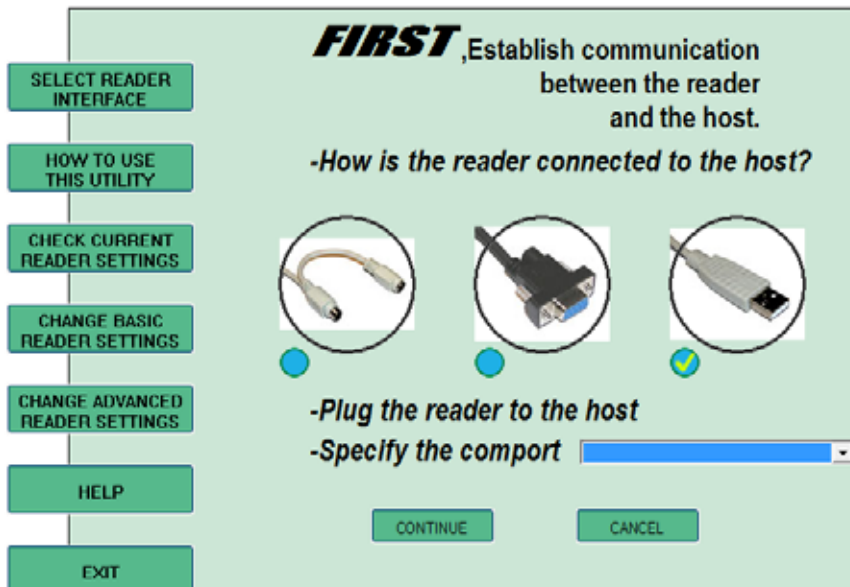

After the interface selection is made, click the **Continue** button. The utility attempts to communicate with the connected reader. If successful, the Home Menu Page is displayed. The Home Menu Page is shown below.



Change Basic Reader Setting

After selecting the appropriate interface for the reader, select one of the Home Menu Page buttons to proceed with the Magnetic Stripe Reader (MSR) configuration process. The "Basic Reader Settings" group defines the basic operating parameters and data output format of the reader.

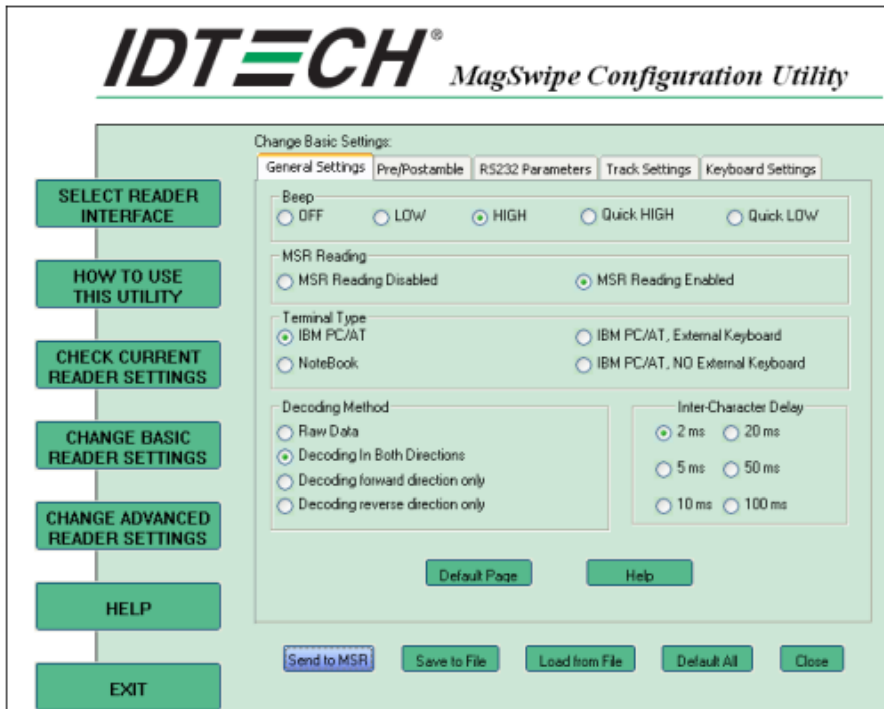

Button Definitions

Send To MSR

When all the setting parameters are selected, use the "Send To MSR..." button to send configuration data to the reader device. When the reader has received the data correctly, the settings take effect immediately.

Load From File

The configuration data can be loaded into the configuration utility from a file that has been previously saved. Select this command, start a "File Open" dialog, which allows selection of the file.

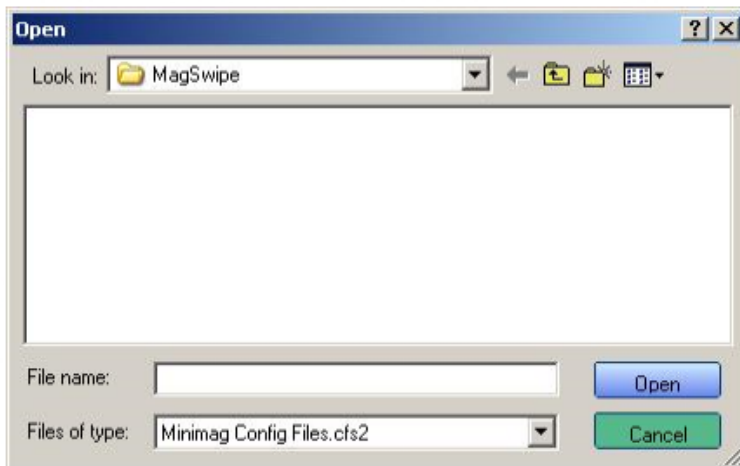

Save To File

The configuration data can be saved as a file and being used later to configure other readers. When saving a configuration the "File Save" dialog is opened as shown below. Input a filename and file location.

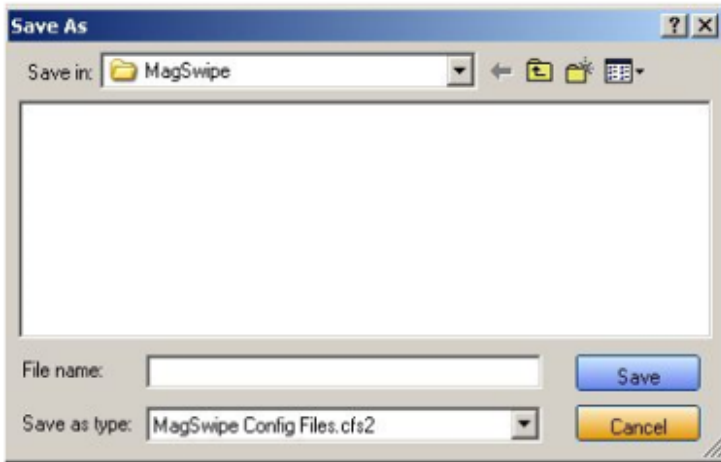

Default All

This button sets the reader with the default configuration parameters (the default factory settings). The settings take effect immediately. The default parameters affect all reader configurations settings.

Close

Close this dialog and return to the Home Menu Page.

General Settings

This group of configuration settings defines the basic operating parameters of the reader.

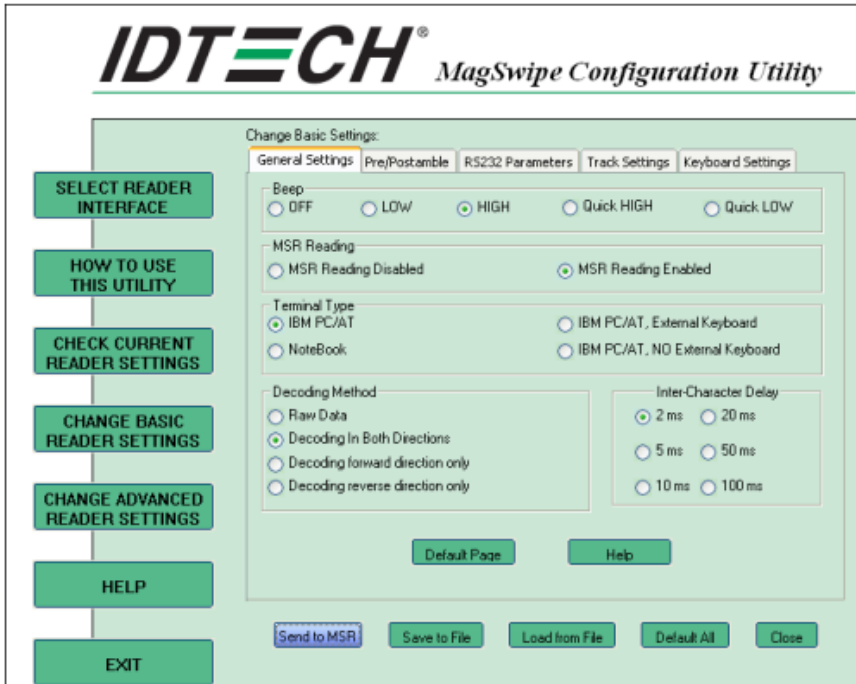

MSR Reading

This option will turn on or off the MSR. If MSR is disabled, no data is sent out to host in any case. The default is MSR Reading Enabled.

Decoding Method Settings

This option gives four kinds of decoding methods.

- Raw Data (output in both forward and reverse directions)
- Decoding in Both Directions (forward and reverse reading)
- Decoding in Forward Direction only (card entering slot from LED end)
- Decoding in Reverse Direction only (card entering slot from end opposite LED)

With the bi-directional operation, the user can swipe the card in both swipe directions and the data encoded on the magnetic stripe will be output. In the single swipe direction selections, the card can only be swiped in one specified direction to read the card. The default setting will decoding card data with the card swiped in either the forward or the reverse direction.

"Raw Data" is an output of the decoded magnetic stripe data in hexadecimal format (no ASCII character conversion is performed). In the Raw Data setting, the reader outputs all track-decoded data. The MSR will represent the raw data with two ASCII characters: the first ASCII character is for high bits of the raw data byte and the second is for the low bits. For example, the two ASCII characters "4" and "1" represent raw data byte 41h (01000001).

DEVICE DRIVER INSTALLATION

Beep Volume

The Beep volume can be adjusted to four loudness levels or off. Four loudness levels are:

- Quick High
- Quick Low
- High
- Low

The default is High beep.

Terminal Type

NoteBook

IBM-PC/AT

IBM-PC/AT, External keyboard

IBM-PC/AT, No External keyboard

The firmware can be programmed to interface as a keyboard wedge to 4 different types of terminals. The default is IBM-PC/AT.

Inter-Character Delay:

2ms, 5ms, 10ms, 20ms, 50ms, 100ms;

This is the time period the reader will delay between sending successive characters. Some terminals or computers (host) require an inter-character delay to simulate the effects of keystroke delays. Choosing a longer inter-character delay causes the characters to be sent at a slower rate. If the host system is not capable of receiving characters as fast as the reader can transmit, setting an appropriate inter-character delay will keep the reader from overrunning the host input buffer. The default is 2ms.

Default Page Button

After you click the Default Button, the general settings page will change back to the default value. Settings are not sent to MSR until the "Send to MSR" button is clicked.

Help Button

Click the help button to open the help index for this section.

Pre/Postamble

Preamble

Characters can be added to the beginning of the reader's output string of data. These can be special characters for identifying a specific reading station, to format a message header expected by the receiving host, or any other character string. Up to nine ASCII characters can be defined for the Preamble.

Postamble

The Postamble serves the same purpose as the Preamble, except the extra characters are added to the end of a data string. The Postamble can be added only after a terminator character, if specified.

Track Prefix and Suffix

For some Host applications, it may be convenient to start or end a string of reader data with a Sentinel or terminator character. The maximum Prefix/Suffix string is six characters and its default is NULL(no prefix or suffix).

Track Start Sentinels

Characters can be added to the beginning of each track data string to simulate the start of the track data. These can be special characters for identifying a specific track.

End Sentinel

The magnetic stripe End Sentinel character can be added to the end of a magnetic stripe data string. This character simulates the end of character for track1, track2 or track3. This default is '?'

Track Settings

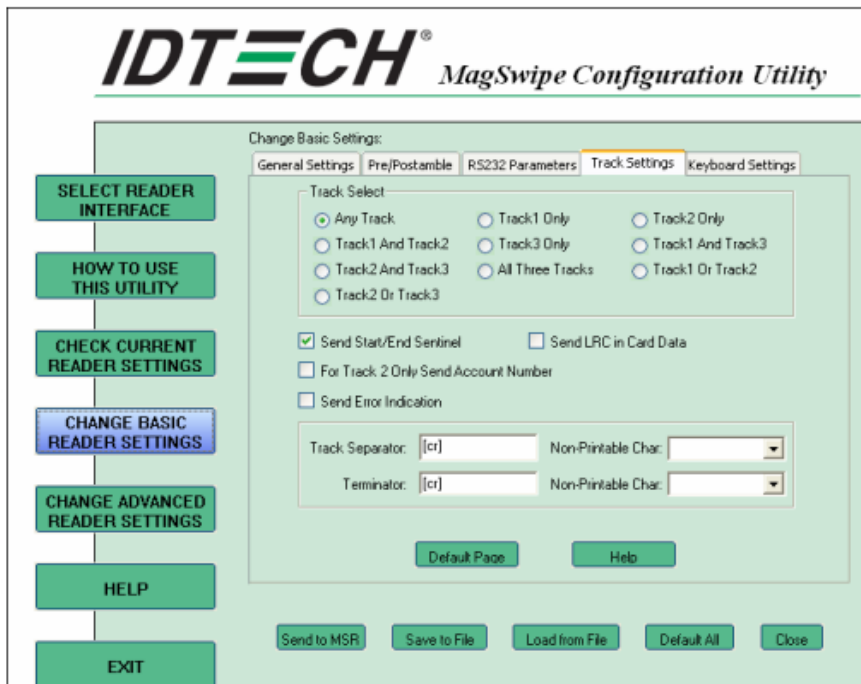

Track Selection

There are three tracks of information possible on a magnetic stripe. This option selects the tracks that will be decoded (read). Note that the magnetic stripe reader must have the hardware configuration (read head and circuits) for reading the specified tracks. If a single or dual track reader is used, the heads must be positioned to read the tracks selected by this option. The default is Any Track. (All tracks written on the card will be read).

Track Separator Selection

This option allows the user to select the character to be used to separate data decoded by a multiple-track reader. The default value is CR.

Send Start/End Sentinel

The reader can send the Start/End sentinel for a track, decoded without error.

Send LRC in Card Data

The reader can send the track LRC for a properly decoded track.

For Track 2 only Send Account Number

The reader can only send account Number if it is true. And if it is false, the reader sends all Track 2 data.

Send Error Indication

This option let reader to send out [SS]E[ES] if failed to read or missing data on a selected track.

The default is off.

The error output for track 1 is "%E?".

The error output for track 2 is ";E?".

The error output for track 3 is "+E?".

Keyboard Settings

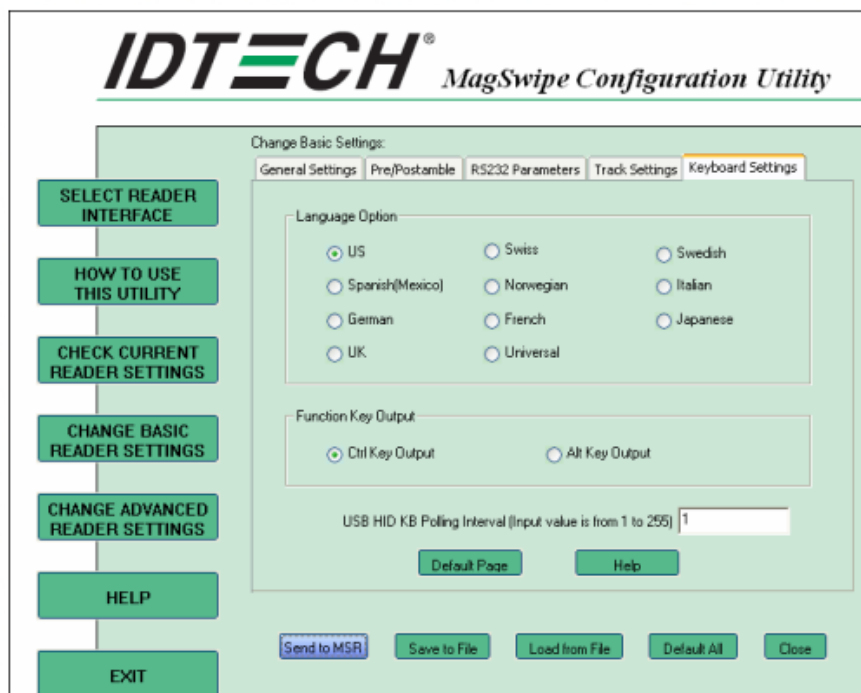

Keyboard Settings

There are keyboard settings information on a magnetic stripe. MiniMag II will support following foreign language keyboard and function key output for PS/2 and USB HID Keyboard Interface.

Language Option

This option allows the user to select the keyboard language of US, Swiss, Swedish, Norwegian, Italian, Spanish (Mexico), German, French, Japanese, UK and Universal. Universal language sends out all the data as a series of ALT keypad sequence.

Function Key Output

The function key output be used to support the special key to delay card data output.

DEVICE DRIVER INSTALLATION

USB HID KB Polling Interview

The user can input the number between 1 to 255 for the delay of output.

Check Current Reader Setting

After you connect the device, the current reader configuration can be displayed by selecting this button.

The configuration data of the connected reader will be displayed like in the example:

```
=====Check Current MagSwipe Settings=====
Software version: MagSwipe Configuration UtilityVersion 2.3.5.0
Beep Volume: HIGH
Track Select: Any Track
Track Separator: \cr
USB HID Format: USB HID KB Data Format
Terminator: \cr|
Send Out Format:
    Send Start/End Sentinel
    Send All Data For Track2
    Not Send Error Indication
    Not Send LRC
Enable/Disable MSR: Enabled
Format & Direction: Decoding In Two Swiping Direction
Track 1 7 bit encoding Start Sentinel: %
Track 1 6 bit encoding Start Sentinel: %
Track 1 5 bit encoding Start Sentinel: ;
Track 1 End Sentinel: ?
Track 2 7 bit encoding Start Sentinel: %
Track 2 5 bit encoding Start Sentinel: ;
Track 2 End Sentinel: ?
Track 3 7 bit encoding Start Sentinel: %
Track 3 6 bit encoding Start Sentinel: !
Track 3 5 bit encoding Start Sentinel: ;
Track 3 End Sentinel: ?
Preamble:
Postamble:
PrePAN:4
PostPAN:4
Mask Char:""
Encryption: Triple DES
Security Level:1
Serial number:002T439324
USB HID KB Polling Interval: 1

INTERFACE_TYPE: USB-HID-KB
Firmware Version: ID TECH TM3 SecureMag USB HID KB Reader V 5.40
```

OK

6-2. i-Button reader Configuration utility

The MagSwipe Configuration utility is used to set up the output format of MagSwipe
CIDTestAp V07.01 Operation Manual

1. Device Connection
2. Utility Features
3. Configuration Setup

Version: V01.00 .

1. Device Connection

1. USB (HID) Interface

Select the USB HID device which has been plug into the PC USB port, enter the correct Vendor ID = 0E6A and Device ID then press "OK", different device has its own Device ID., e.g., DID=0x030F for keyboard and HID USB, DID=0x5082 for keyboard, HID and VCP USB.

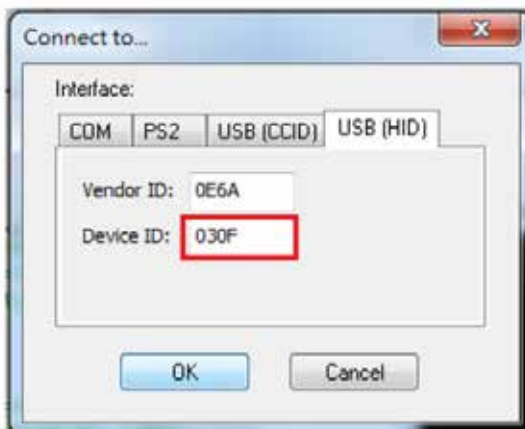

2. Utility Features

After success device connection each supported command will get its response, e.g.

Get Version command should response with the device HW/FW version, for all command set supported please reference its programming guide.

There are two command/response windows can be used (see block1 & 2).

For second level device the Indirect command signal should be selected (see block3 & 4). Press the button "Configure Word" to enter the parameter setting function (see Block 5). The two response windows show up the data from the device connected.

DEVICE DRIVER INSTALLATION

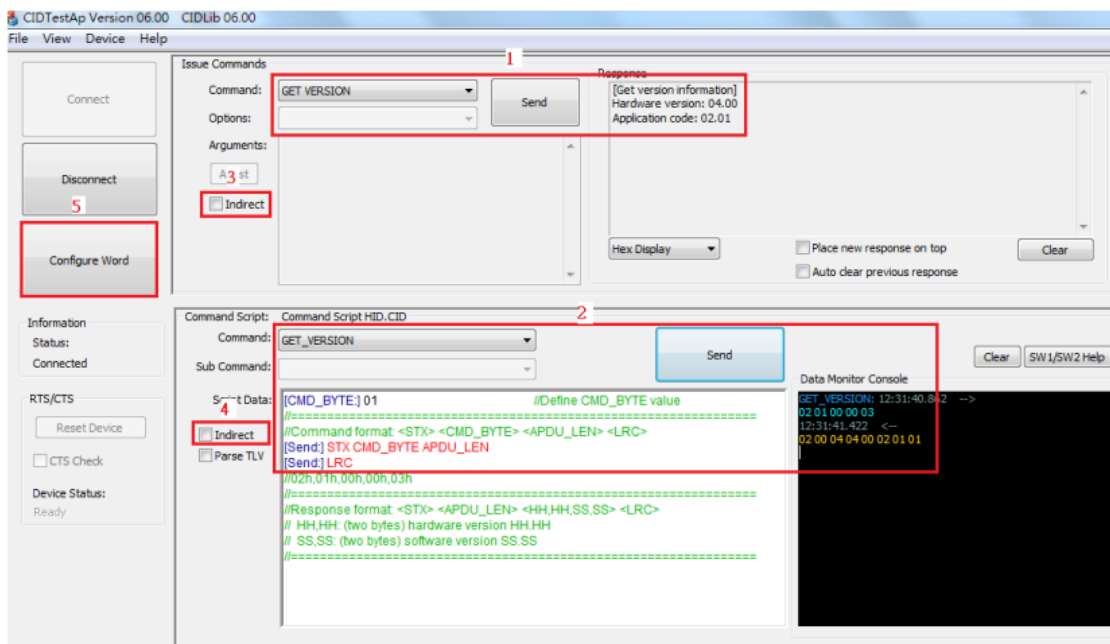

2. Configuration Setup

Device functions (e.g., MSR, i-Button, RFID, Chip card) behavior can be defined and stored by this tool.

Four operation buttons define as below:

- “Load From File”: Load the previous setting configuration file from storage.
- “Save To File”: Save the current screen setting to file in storage.
- “Get Configuration Word”: Get current setting in the device connected.
- “Set Configuration Word”: Set current setting on the screen to the device connected.

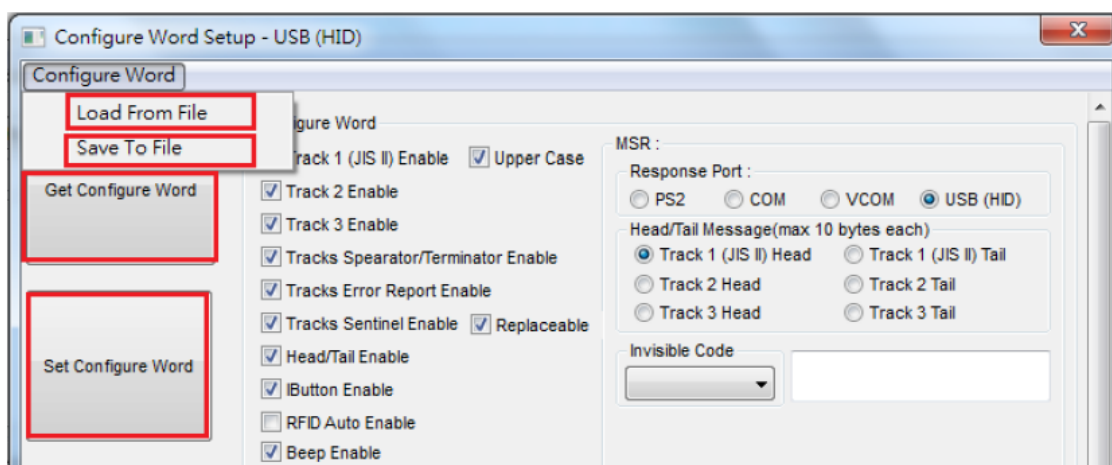

DEVICE DRIVER INSTALLATION

16 parameter areas (see below) are used for four functions, each function related area should be setup correctly and press Set Configure Word button before operation.

MSR function areas: 1,2,5,6,9,11,12,13

i-Button function areas: 2,3,5,7,10,11,14

RFID function areas: 2,4,5,8,11,15

Chip card function areas: 16

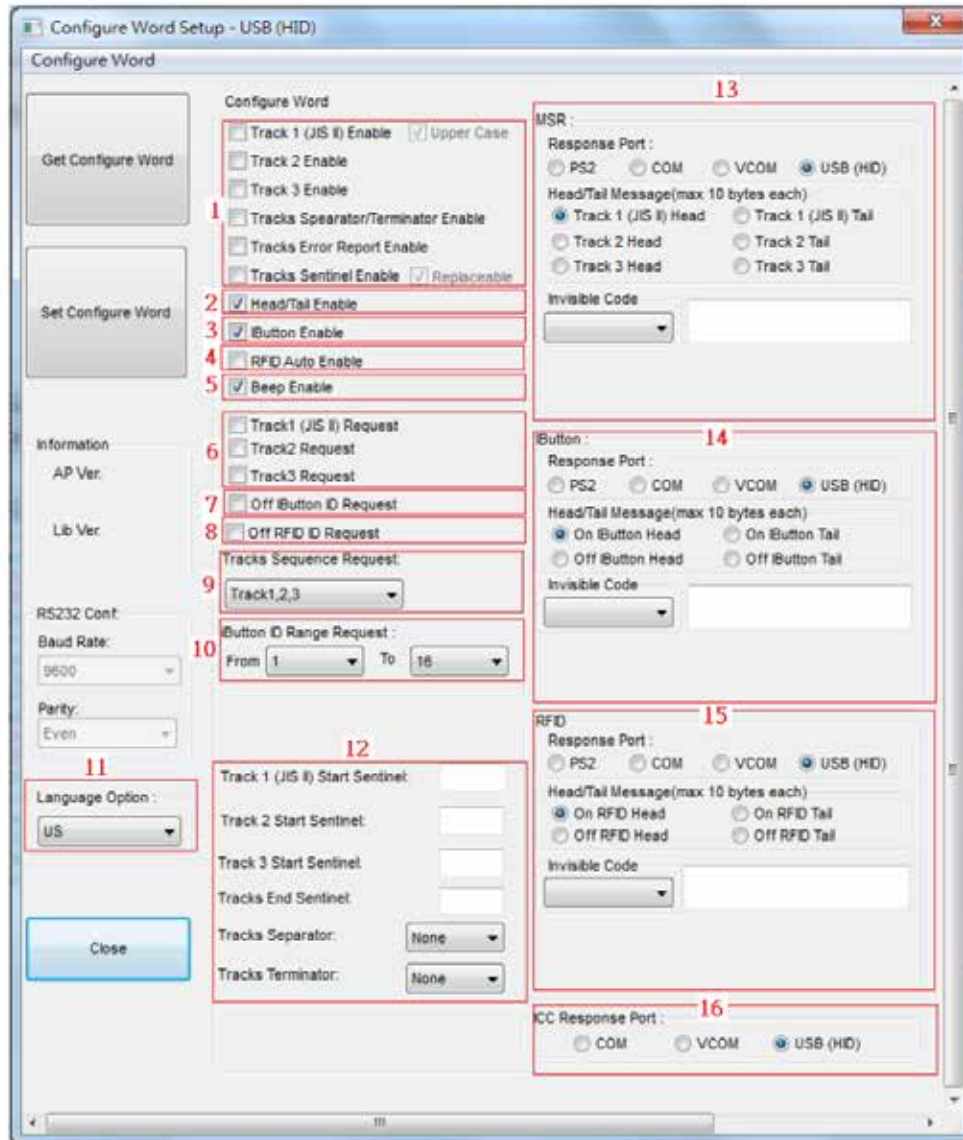

DEVICE DRIVER INSTALLATION

Configure word detail

Area 1

Track 1 (JIS II) Enable:	If enabled, the track 1 data will response.
Track 2 Enable:	If enabled, the track 2 data will response.
Track 3 Enable:	If enabled, the track 3 data will response.
Upper Case:	If selected, the track1 data read will transfer to upper case before response.
Track Separator /Terminator Enable:	If enabled, the reader will send Track Separator and Track Terminator code defined in this configure word between tracks data or after the last track data.
Track Error Report Enable:	If enabled, the character "F" will response when track data read fail.
Track Sentinel Enable & Replaceable:	If enabled, the reader will send start and end sentinel at begin and last position of each track data. If replaceable, these sentinels will be replaced by the sentinel defined in this configure word.

Area 2

Head/Tail Enable:	If enabled, all of the Head/Tail message defined in this configure word will prefix and suffix to each data returned.
-------------------	---

Area 3

i-Button Enable:	If enabled, i-Button key ID may response when key attached or removed.
------------------	--

Area 5

Beep Enable:	If enabled, the beeper will activate to indicate the operation result.
--------------	--

Area 6

Track 1 (JIS II) Request:	If selected, the reader will response track data only if track1 read correctly.
Track 2 Request:	If selected, the reader will response track data only if track2 read correctly.
Track 3 Request:	If selected, the reader will response track data only if track3 read correctly.

DEVICE DRIVER INSTALLATION

Area 7

Off i-Button ID Request:	If selected, key ID will response while key removed.
--------------------------	--

Area 8

Off RFID ID Request:	If selected, RFID ID will response while RFID card removed.
----------------------	---

Area 9

Tracks Sequence Request:	Select the order of three tracks data returned.
--------------------------	---

Area 10

i-Button ID Range Request:	Define the i-Button data range returned.
----------------------------	--

Area 11

Language Option:	Select one of supported keyboard language for PS2 or keyboard USB interface.
------------------	--

Area 12

Track 1 (JIS II) Start Sentinel:	Define Track 1 Start sentinel byte, default is "%".
Track 2 Start Sentinel:	Define Track 2 Start sentinel byte, default is ",".
Track 3 Start Sentinel:	Define Track 3 Start sentinel byte, default is "+".
Tracks End Sentinel:	Define all Tracks End sentinel byte, default is "?".
Tracks Separator:	Define the insertion byte between each track data returned.
Tracks Terminator:	Define the appending byte after the last track data returned.

Area 13

MSR Response Port:	Select MSR data response port right after swiped.
Head/Tail Message:	Message prefix and suffix to each track data returned.
Each Head/Tail accepts 10 bytes max. long. Invisible code:	Enter keyboard control code.

DEVICE DRIVER INSTALLATION

Area 14

I-Button Response Port:	Select i-Button key ID response port right after key attached or removed.
Head/Tail Message:	Message prefix and suffix to key data returned. Each Head/Tail accepts 10 bytes max. long.
Invisible code:	Enter keyboard control code.

Area 15

RFID Response Port:	Select RFID ID response port right after tag attached or removed.
Head/Tail Message:	Message prefix and suffix to tag data returned. Each Head/Tail accepts 10 bytes max. long.
Invisible code:	Enter keyboard control code.

Area 16

ICC Response Port:	Select chip card auto. ATR response port
--------------------	--

6-3. VFD

1. Power on VFD and waiting test page of EEPROM test, Baud rate and Command page.
Set up the customer display by " VFDset.exe"
2. Setup VFDset.exe software.

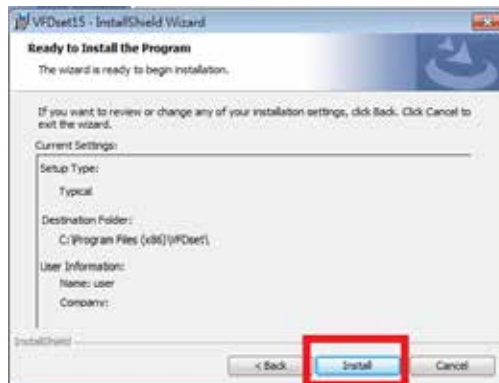
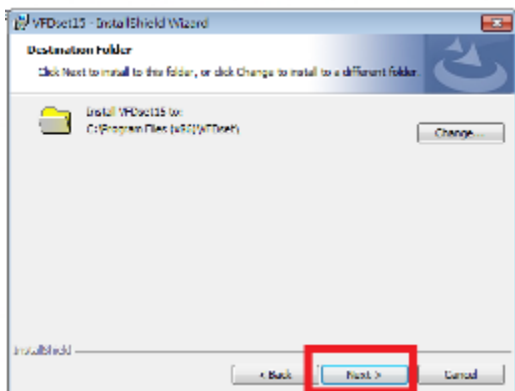
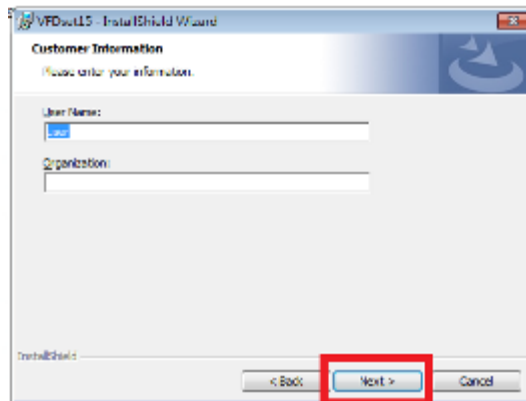
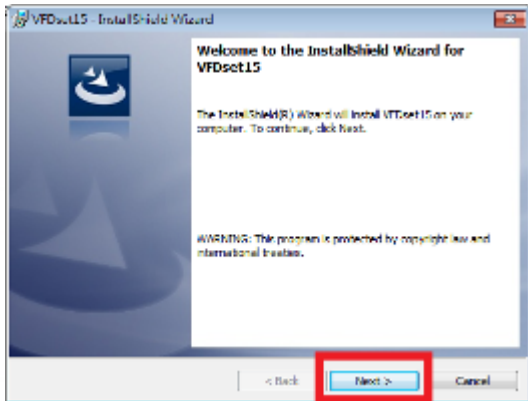

DEVICE DRIVER INSTALLATION

3. To execute "VFDset.exe" for setting up communication between software and VFD module.

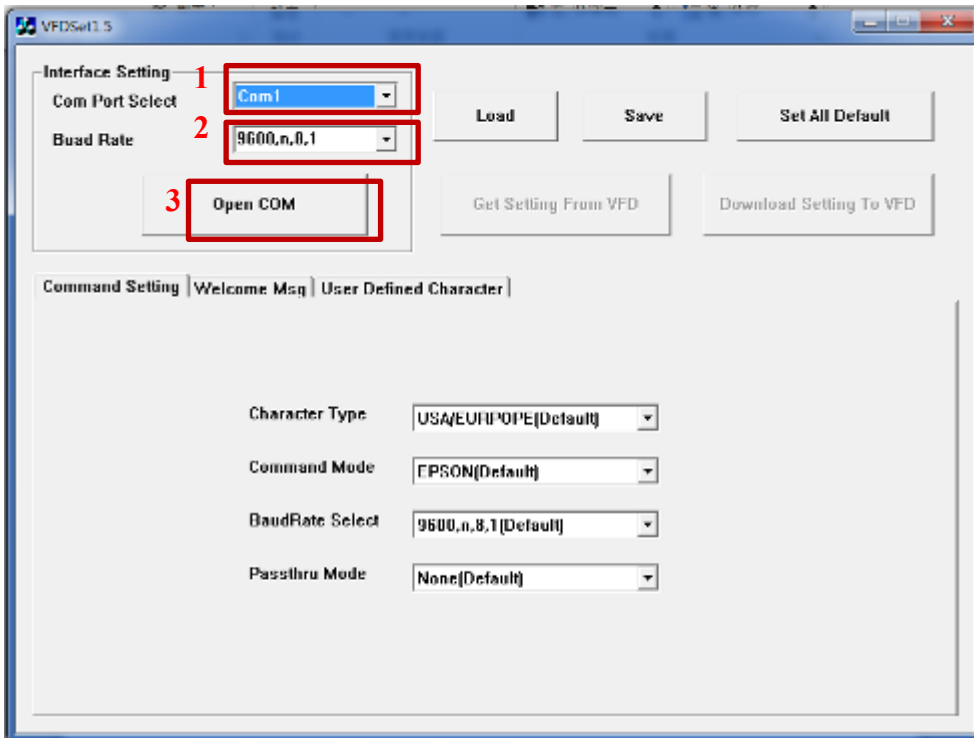

Please then follow the steps as shown in the above figure, the baud rate will show on states page of VFD (Note: You may check it when power on VFD module), then click "Open COM" button.

4. "Get Setting from VFD" button to get all the settings from VFD and it'll refresh the "VFDset.exe" softw:

5. Select "Character Type" / "Command Mode" / "Baud Rate Select" / "Passthru Mode".

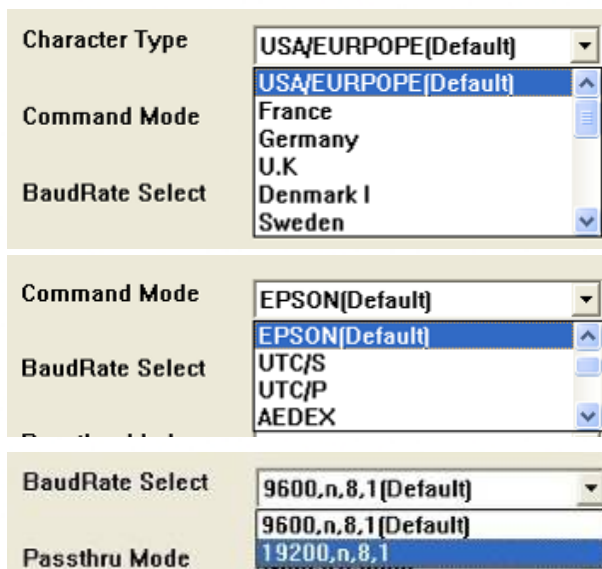

DEVICE DRIVER INSTALLATION

6. Click "Set All Default" button to show default setting, the Default table is

Character Type: USA
 Command Type: EPSON/EUROPE
 Baud Rate Setting: 9600/n/8/1
 Pass-through Mode: None
 Welcome msg line1: *** VFD DISPLAY ***
 Welcome msg line2: **HAVE A NICE DAY AND THANK YOU**

7. Welcome Message

Welcome Message line1 maximum 20 characters, line 2 maximum 20 characters, total of 40 characters.

- a. ASCII mode

You can type the character by keyboard (0x20h ~ 0x7Fh), if you press clear icon, it will clear all Message characters on AP.

- b. Hex mode

Hex mode can define the character from 0x20h to 0xFFh · the range 0x80~0xFF which depends on the code page table.

Like the first character (0x80) · in default code page will show on VFD module.

DEVICE DRIVER INSTALLATION

8. Click "Download setting to VFD" button

This button is to download the setting from VFDset.exe to VFD module. After success dialog "Download O.K! Please restart!" message popped up. Please restart display for enable new setting

9. Click "Save" button

To save user's setting in file; for example, below picture to save file name as "GOODLUCK" file

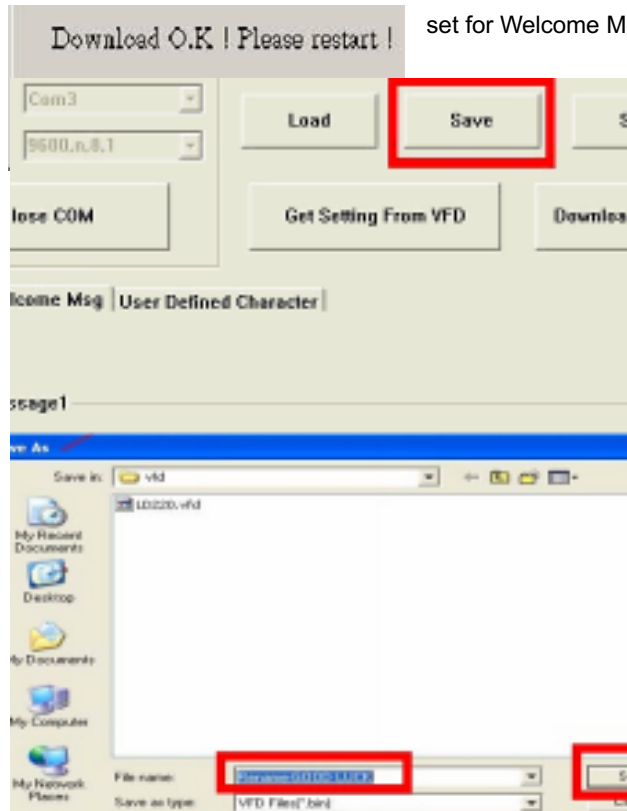

DEVICE DRIVER INSTALLATION

10. Click “Load” button

After saving, you must restart the utility here. Then load your setting rename-GOODLUCK.vfd.

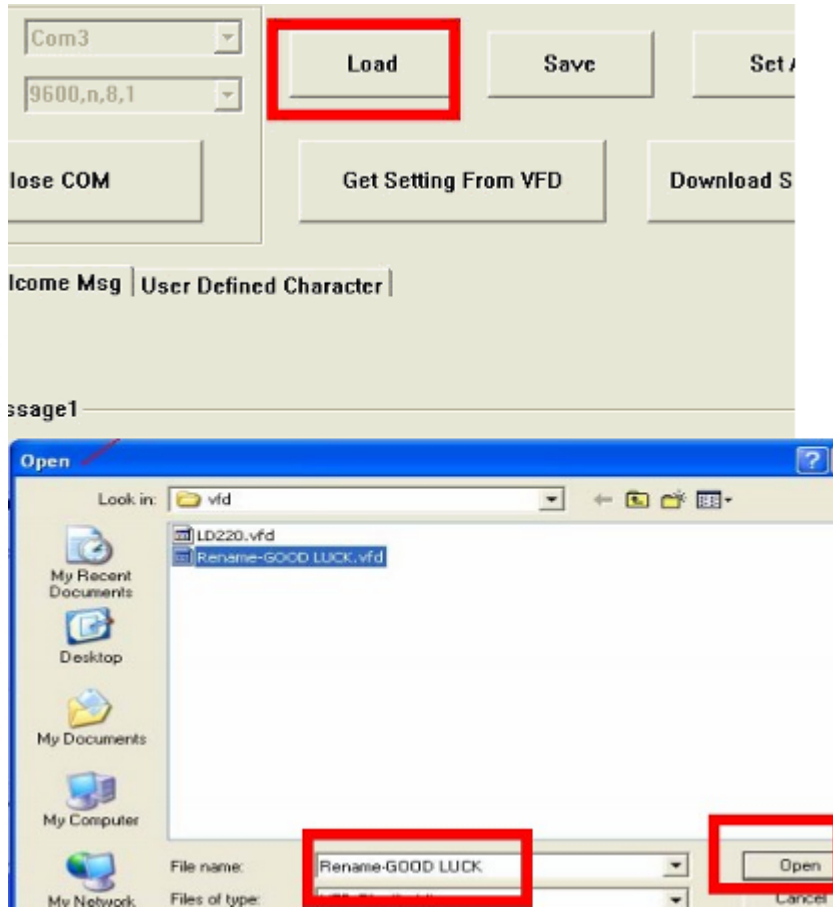

6-3. RFID

6-3-1. Install driver

1. Check the Device Manager to verify the status of RFID reader.

Computer Management -> Device Manager -> Other devices

(The device will show a question mark if the installation is not done properly.)

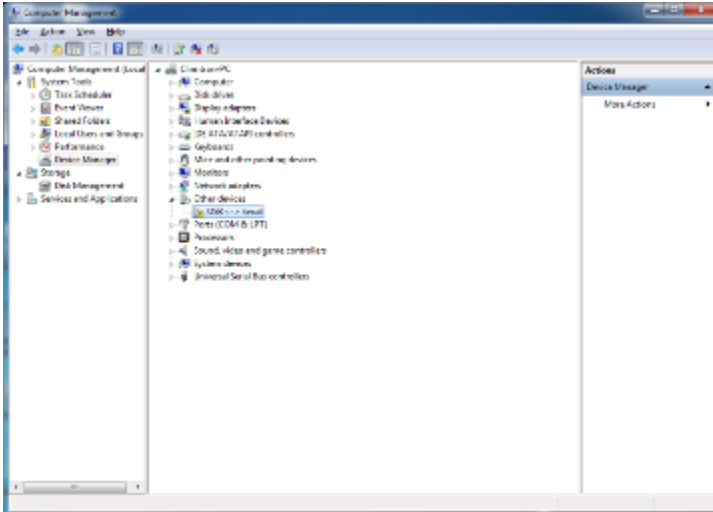

2. Double-click to update driver.

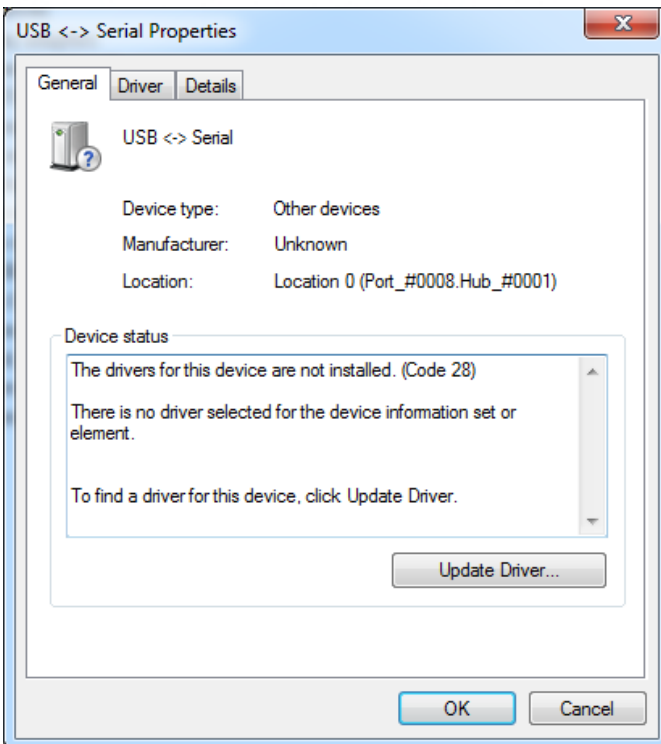

DEVICE DRIVER INSTALLATION

3. Select “Browse my computer for driver software.”

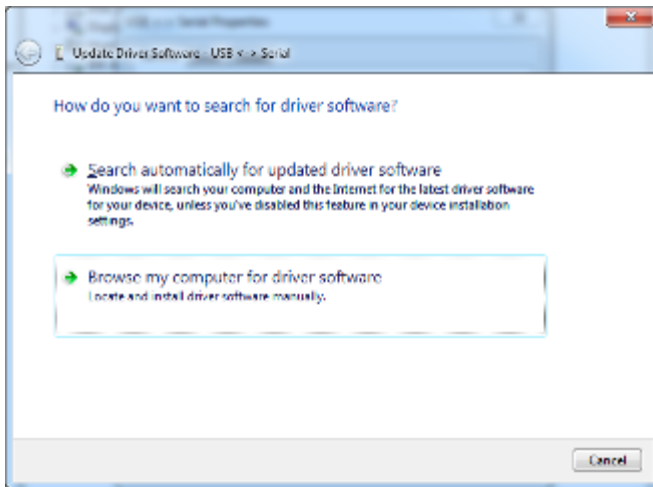

4. Click Browse to select file called MP30U \Driver\FTDI\x64

And click Next.

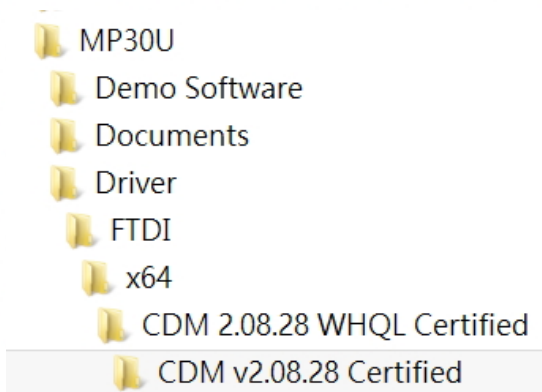

5. Install the driver

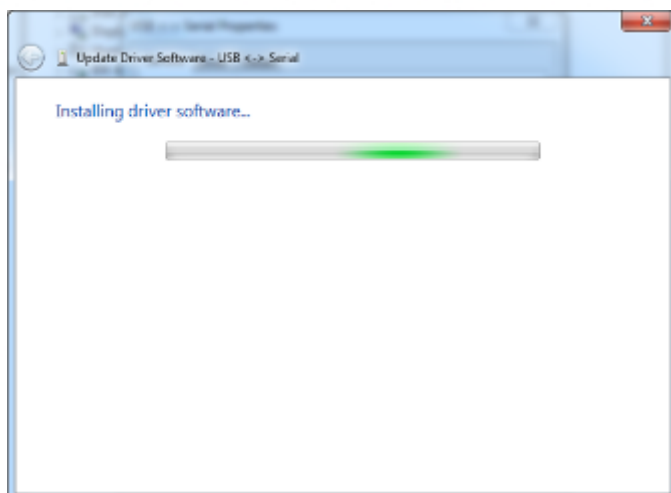

DEVICE DRIVER INSTALLATION

6. Install complete and then click “Close”

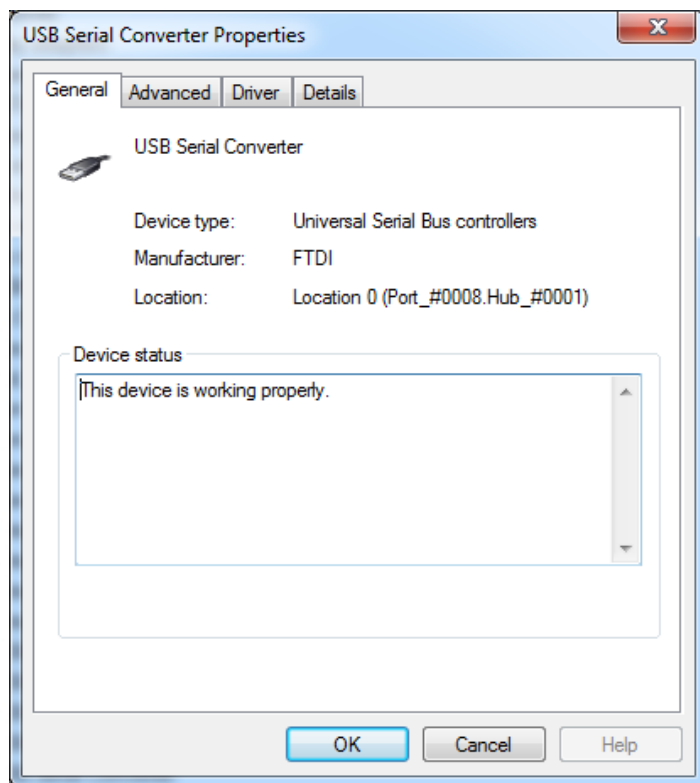

7. Restart the computer

6-3-2. Install framework 4.0

1. Double-click to install.

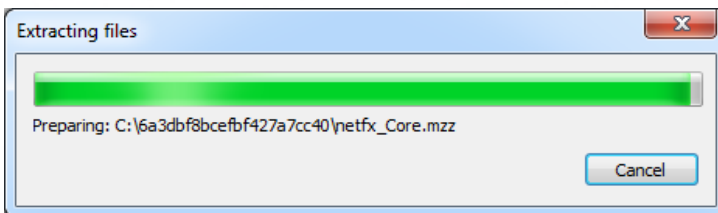
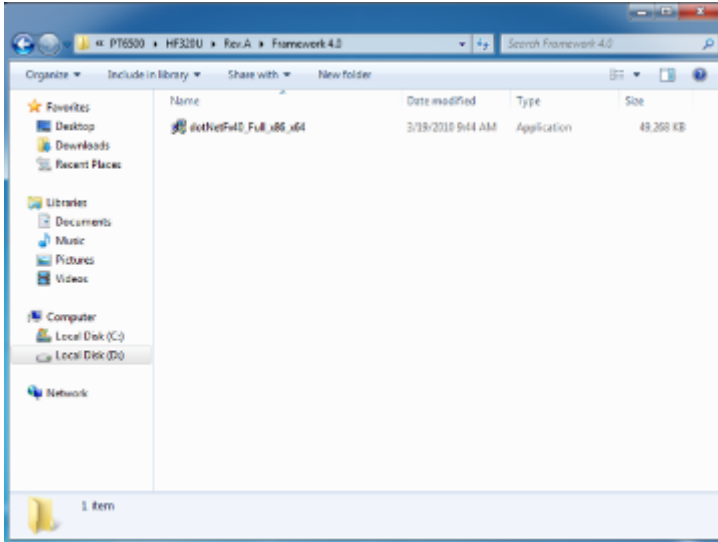

2. Select "I have read and accept the license terms. And click Install.

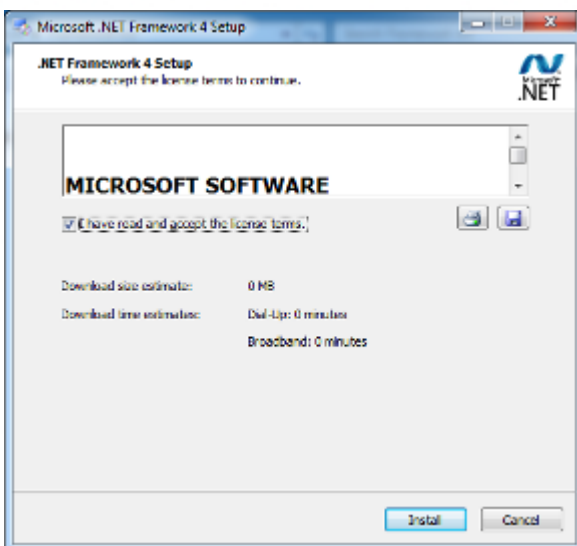

DEVICE DRIVER INSTALLATION

3. Click Finish.

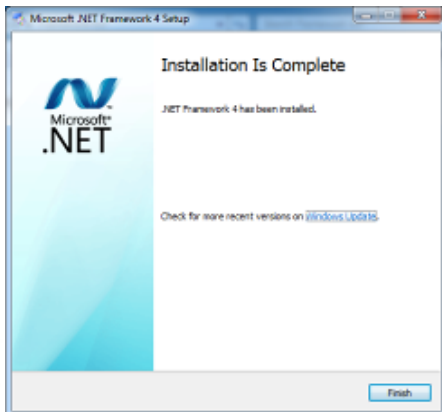

6-3-3. Quick Start with Demonstration Software

1. The demonstration software is "MP Studio.exe" provided in the folder "Demo Software". There is no software setup required; just double click the "MP Studio.exe". The demonstration software can run either from CD or a copy on hard drive. The GUI of software is shown in the picture below and ready to use.

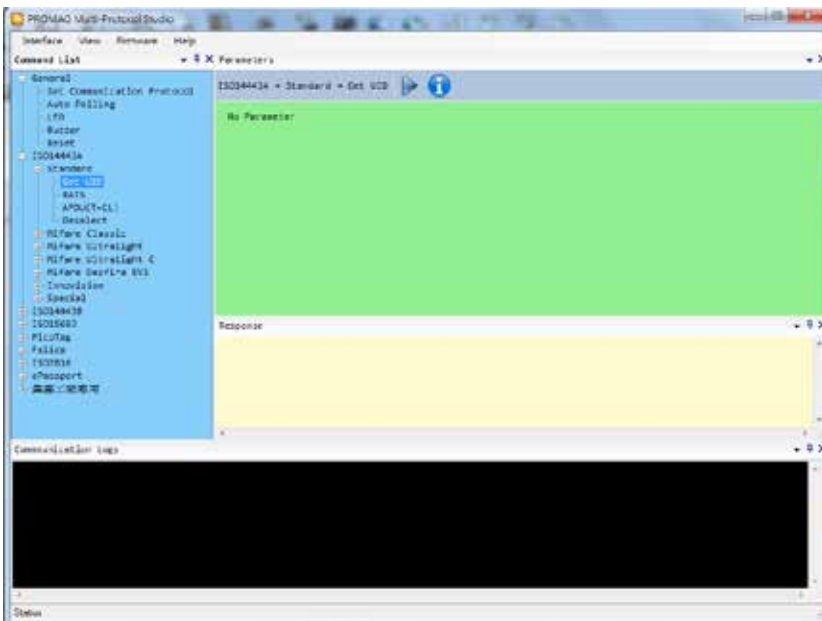

DEVICE DRIVER INSTALLATION

3. Following steps, as shown in the picture below, demonstration a simple usage in reading UID of ISO14443A card for quick understanding.

The image illustrates the process of reading the UID of an ISO14443A card through a software interface, divided into seven numbered steps:

- 1**: Selecting the serial port. The 'Serial Ports' menu is open, and 'COM19' is highlighted.
- 2**: Setting the communication protocol. In the 'Command List' window, 'Set Communication Protocol' is selected, and 'ISO14443A' is chosen from the list.
- 3**: Selecting the specific command. Under the 'ISO14443A' category, the 'Standard' sub-category is expanded, and 'Get UID' is selected.
- 4**: Executing the command. The 'Send Command' button is clicked, and the command 'ISO14443A → Standard → Get UID' is shown.
- 5**: Viewing the response. The 'Response' area displays the following information:
Response Time:18:48:24.768
Response OK
UID:04874821BD2580
- 6**: The response area is highlighted.
- 7**: Viewing the communication logs. The 'Communication Logs' window shows the following data:
RX_0001> AE 00 0A 01 00 01 04 87 48 21 BD 25 80 F8
TX_0001> AE 00 02 01 00 03
RX_0000> AE 00 03 00 00 01 02
TX_0000> AE 00 03 00 00 00 03

1. Press key to enter SETUP CMOS UTILITY when system is booting up.



2. Press <ENTER> over SCU button to enter the utility

insyde
13th Gen Intel(R) Core(TM) i3-8145UE CPU @ 2.20GHz
 DRAM Frequency: 2400 MHz
 Memory Size: 32768 MB

2021/02/26 13:56:49
FRJ

HDD TEMPERATURE 00°C
 CPU TEMPERATURE 59°C

Main

Processor Type	Intel(R) Core(TM) i3-8145UE CPU @ 2.20GHz
System Bus Speed	100 MHz
System Memory Speed	2400 MHz
Cache RAM	512 KB
Total Memory	32768 MB
Channel A	
SODIMM 0	16384 MB
Channel B	
SODIMM 0	16384 MB
Platform Configuration	
CPUID:	0x806EC (WhiskeyLake ULT)
CPU Speed:	2400 MHz
CPU Stepping:	806EC (V0 Stepping)
L1 Data Cache:	32 KB
L1 Instruction Cache:	32 KB
L2 Cache:	256 KB

System Time

This is the help for the hour, minute, second field. Valid range is from 0 to 23, 0 to 59, 0 to 59.
 INCREASE/REDUCE : +/-

Date and Time

The Date and Time items show the current date and time on the computer. If you are running a Windows OS, these items are automatically updated whenever you make changes to the Windows Date and Time Properties utility.

WARNING!

Setting the wrong values in the sections below may cause the system to malfunction. Make sure that the settings made are compatible with the hardware.

7-1. Advanced

Use the Advanced menu to configure the system for basic operation through the following sub-menus:

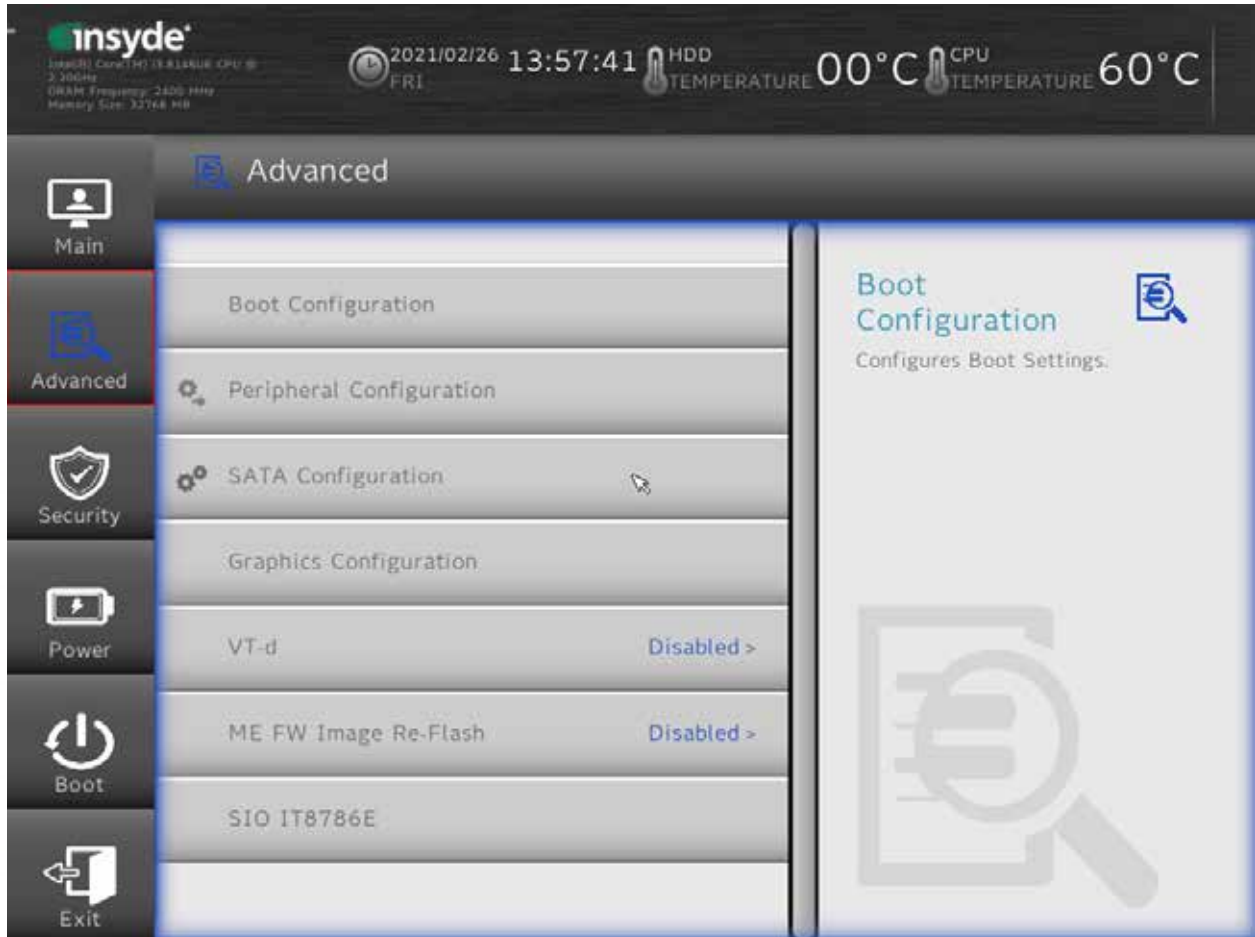

7-1-1. Boot Configuration

Use the Boot Configuration menu to select power-on state for Numlock.

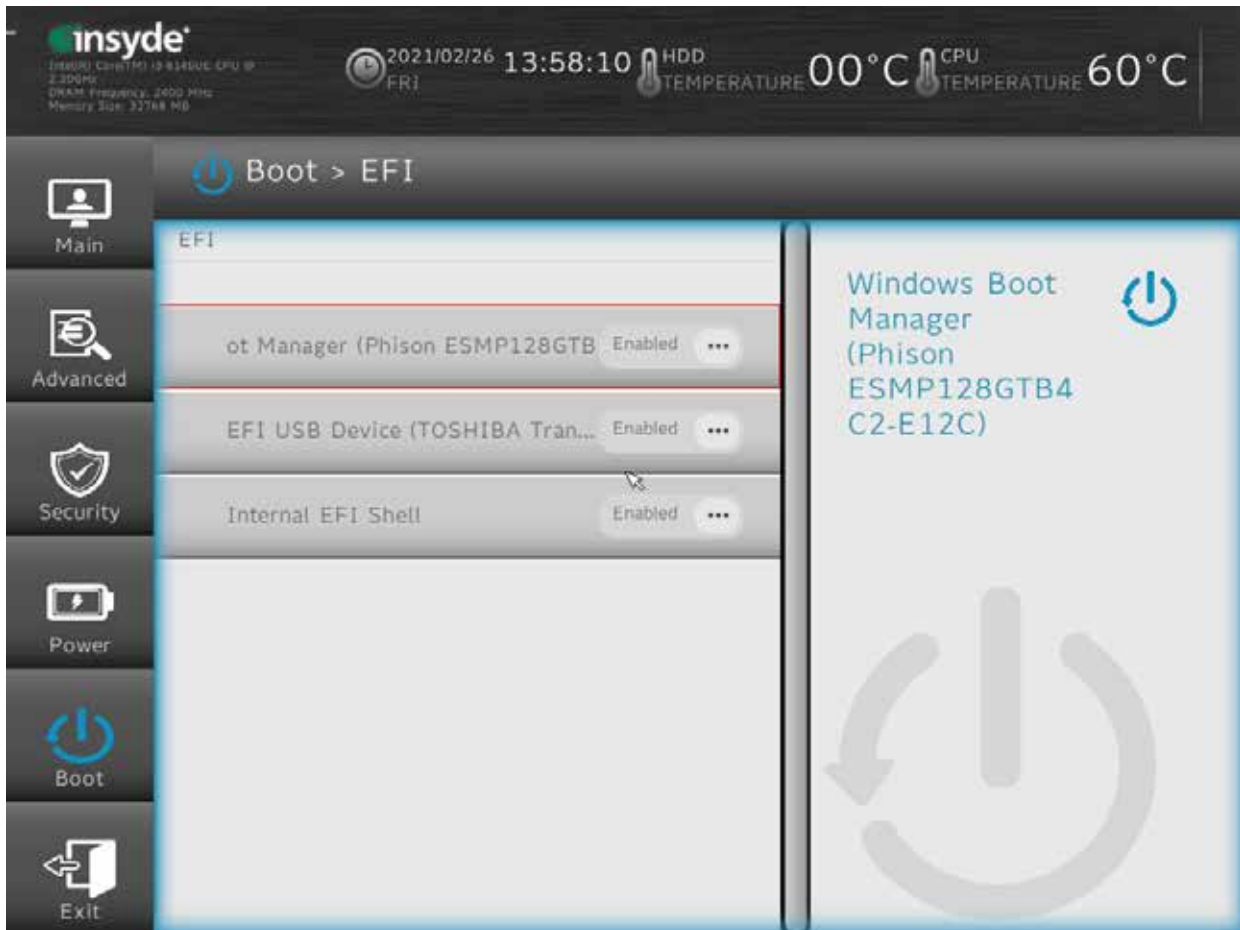

7-1-2. Audio Configuration

Use the Audio Configuration menu to read Audio configuration information and configure the Audio settings

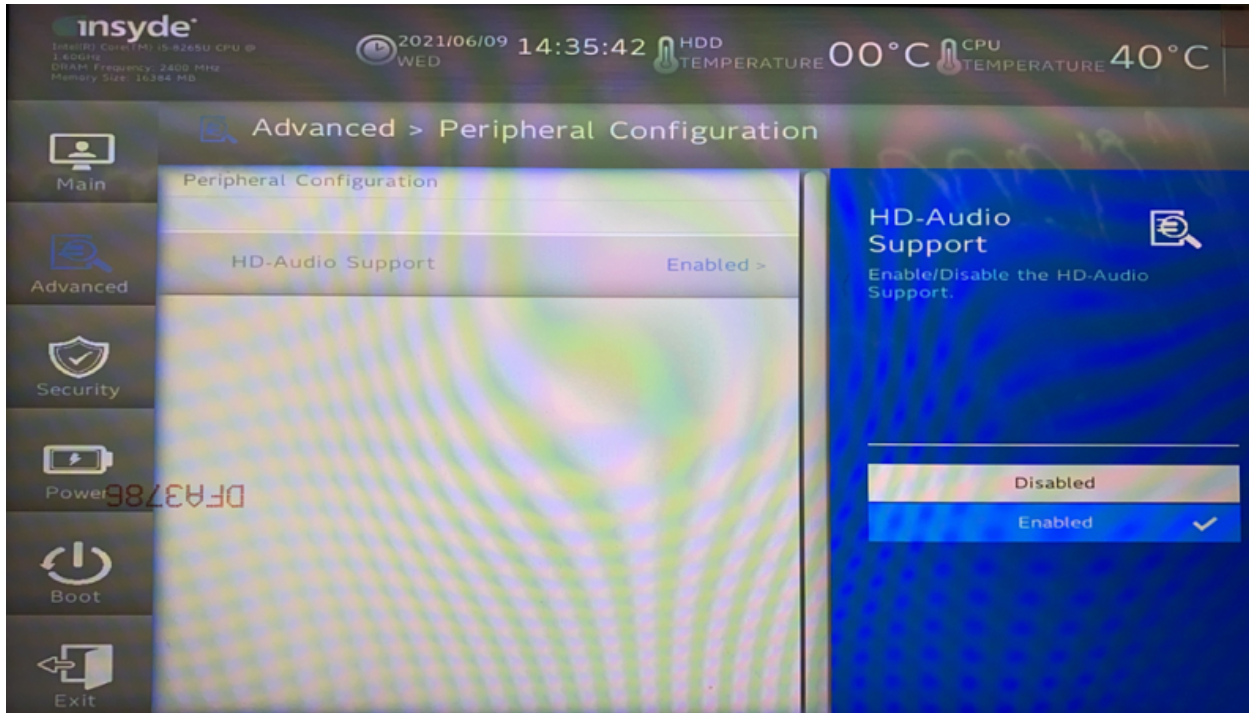

7-1-3. Video Configuration

Use the Video Configuration menu to read Video configuration information and configure the Video settings

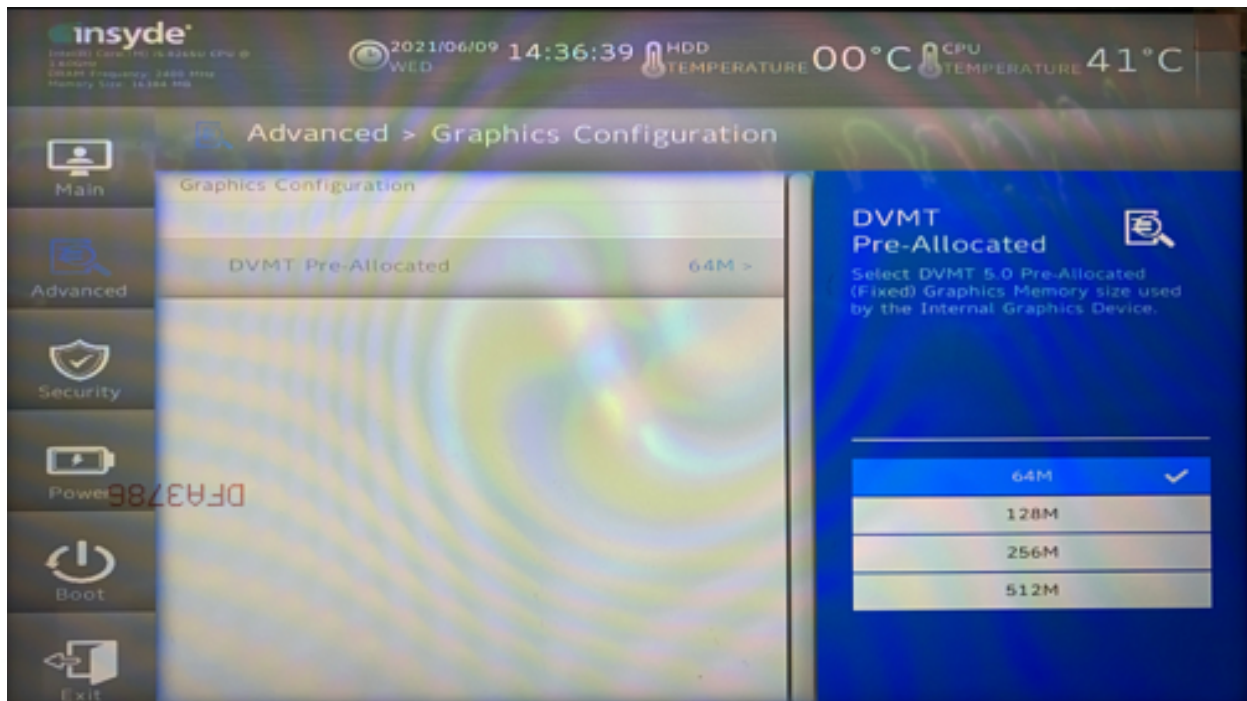

7-1-4. SATA Configuration

Use the SATA Configuration menu to read SATA configuration information and configure the SATA settings

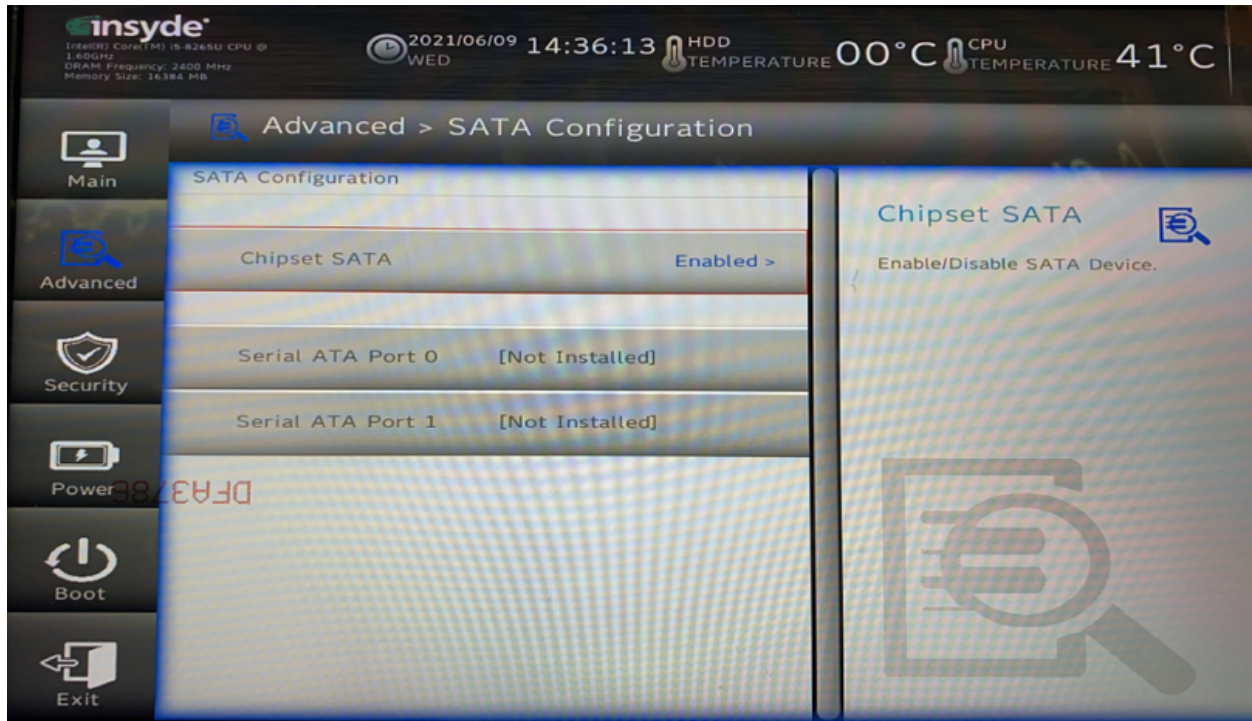

7-2. Security

Use the Security menu.

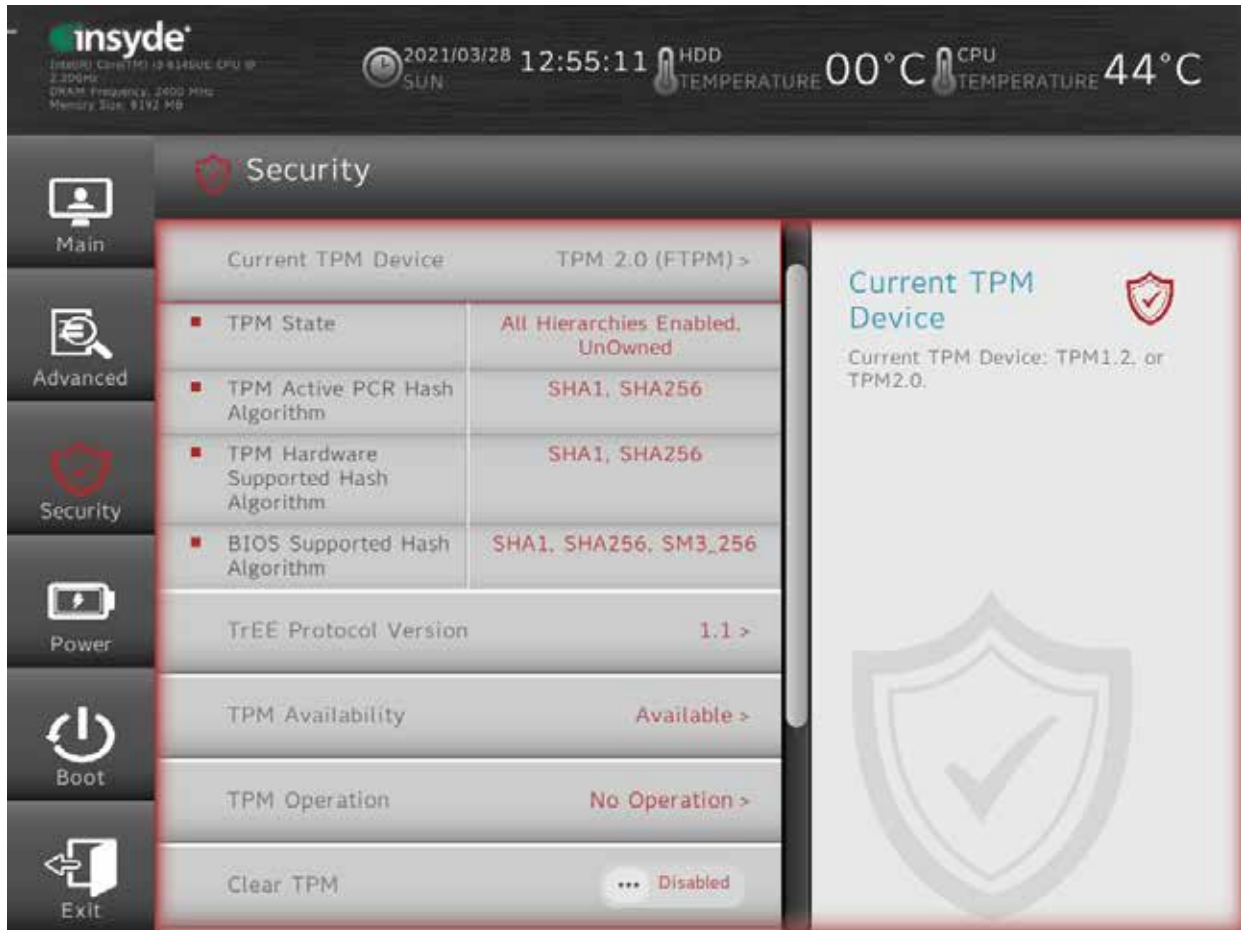

7-3. Power

Use the power menu to install or change the power settings.



AC Loss Auto Restart

Enable or disable system power on automatically after AC power restored

Wake on LAN

Enable or disable system wake by onboard LAN chip

7-4. Boot

Use the Boot menu.

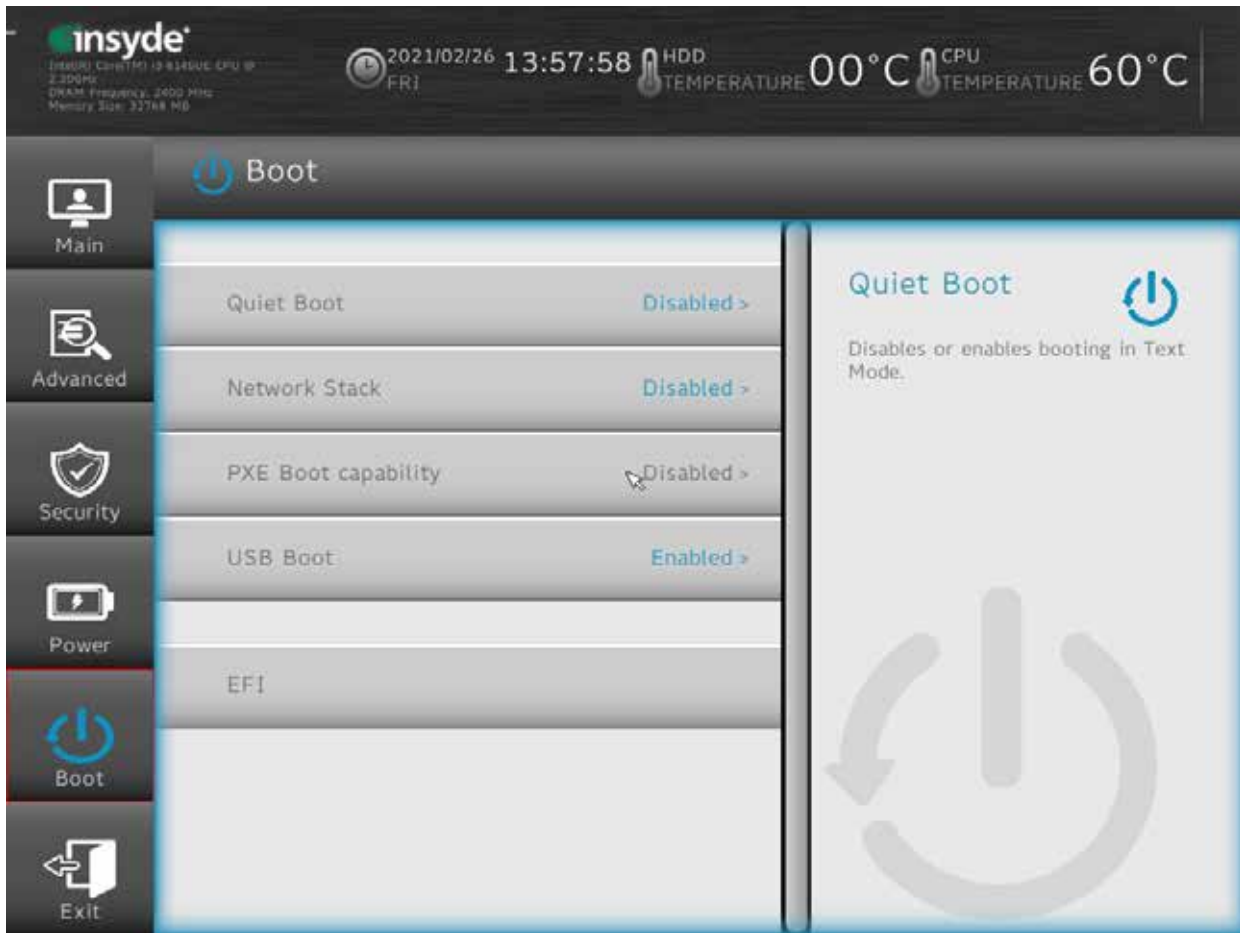

7-5. Exit

Use the Save & Exit menu to load default BIOS values, optimal failsafe values or to save configuration changes.

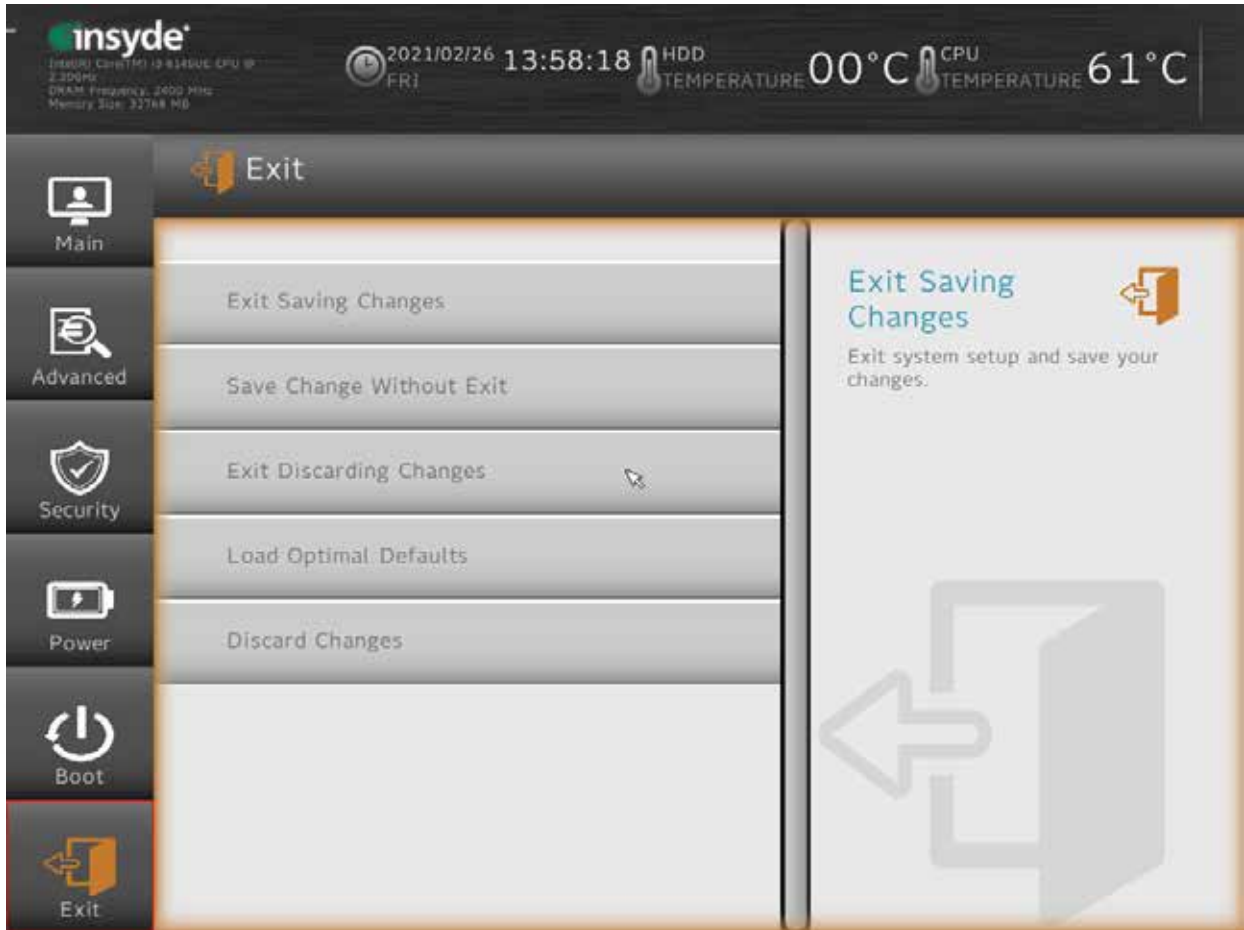

1. How to clean the LCD surface properly?

- ☆ Do not spray any liquids on the LCD screen directly, and do not use paper towels, this can cause the LCD screen to become scratched.
- ☆ Always apply the solution to your cloth first, not directly to the parts you are cleaning. You want to avoid dripping the solution directly into your computer or laptop.
- ☆ Stroke the cloth across the display in one direction, moving from the top of the display to the bottom.

2. What are some of the basic supplies needed to clean an LCD screen?

- ☆ A soft cotton cloth. When cleaning the LCD screen it is important to use a soft cotton cloth, rather than an old rag. Some materials, such as paper towels, could cause scratches and damage the LCD screen.
- ☆ Solution of water and isopropyl alcohol. This solution can be used along with the soft cotton cloth.
- ☆ Computer wipes. Only use these if they specifically state on the package they are designed for LCD laptop screens. Computer wipes can come in handy for fast clean-ups or when you want to avoid mixing up a cleaning solution yourself.

3. What types of cleaners are acceptable?

- ☆ Water
- ☆ Vinegar (mixed with water)
- ☆ Isopropyl Alcohol

NOTICE: The following cleaners are unacceptable:

- Acetone
- Ethyl alcohol
- Ethyl acid
- Ammonia
- Methyl chloride



Colometrics GmbH
Braugasse 5
35390 Gießen
Telefon: +49 641 97226711
E-Mail: info@colometrics.info

www.colometrics.info